

Energy and
Environmental Effects
of High Light
Reflectance Ceilings

Engineering Study

Prepared by



114 North Second Street
Harrisburg, PA 17101-1401
717 . 233 . 4502



www.armstrong.eu

Inspiring Great Spaces™



Introduction

This study investigates the effects of increasing ceiling reflectance on several typical office plans. With standards like those developed by the American Society of Heating, Refrigeration, and Air-Conditioning Engineers (ASHRAE) and the International Energy Conservation Code (IECC) being adopted as code across the United States, there is a clear need to stretch our energy budget further than ever before. The Energy Policy Act of 2005 (EPA 2005)¹ gives tax credits for energy efficient design below ASHRAE 90.1-20012 standards to encourage owners to reduce energy use below the code required minimum. In addition to code requirements and tax credits, many building owners are looking toward further improvements by applying the principles set forth by the United States Green Building Council (USGBC) in the Leadership in Energy and Environmental Design (LEED) programme.

With so much at stake to reduce energy use and environmental impacts, much research is being conducted into new reflector and optical designs, as well as electronics and lamp technology and methods of integrating daylight. Relatively little research has been conducted on other factors affecting lighting design, including topics such as surface reflectance effects or light loss factors. Are the standard 80-50-20 room surface reflectances that most designers assume causing over- or under-design?

While more studies on light loss factor in modern environments need to be conducted, this study's focus is on the specific effects of ceiling reflectance on energy consumption.

The effects were looked at in two different comparative sets. The first investigation held all room properties, including the lighting, consistent, then looked at the effect of the ceiling reflectance on ceiling uniformity and illuminance levels at the work plane. The second investigation used the same light fixtures, lamps, and ballasts, but optimised the design for a variety of ceiling reflectances to reduce as much energy as possible while meeting the Illuminating Engineering Society of North America (IESNA) recommendations in their Recommended Practices for Office Lighting (RP-1-2004)³.

This information was then used to compare the effects of ceiling reflectance to energy saved, energy saved as compared to ASHRAE 90.1-1999⁴ and 90.1-2004⁵ and its effects on the LEED Version 2.1⁶ and 2.2⁷ rating systems respectively, and the effects the reduced lighting load has on the HVAC system. Throughout the following studies, a target illuminance at the task plane of 50 maintained footcandles (fc) was used, to comply with IESNA recommendations for private offices or open office plans with intermittent VDT use. Lower power densities are often achieved through lower ambient target light levels and the use of task lighting. These studies only consider the ambient lighting component.

Review of other studies

Previous studies have shown that there is a potential for significant energy savings when considering high reflectance surfaces. A recent study by Penn State University⁸ showed a power density reduction in classroom spaces of 25 to 29 percent for the electric lighting when increasing the ceiling reflectance from 75% to 90%. This is also similar to the results found by the Weidt Group study⁹, which found that a 25% increase in illuminance levels or an 18% decrease in operating costs could be achieved when using indirect luminaires. A study by Zhang and Ngai¹⁰ has shown that as room reflectance increases, the ceiling uniformity also increases. Other studies that were reviewed mostly involved surface reflectance of objects within the rooms rather than the room surfaces themselves. While these studies also showed promise in energy savings for proper furniture selection, the furniture system can change numerous times in a building's lifetime. Thus, many designers use standard values for these reflectances in case the systems change in the future. Unlike furniture systems or even wall colour, ceiling systems are rarely changed unless there is a major renovation of a space. This provides a solid, reliable foundation upon which to base the lighting design. Thus any change in the ceiling system's reflectance could have long term impacts on the lighting system.

Software

Each of the studies was conducted using a minimum of three lighting software packages to verify the results. It should be noted that while the results did vary between the programmes, the variances were not statistically significant. The software packages utilised in these studies are as follows:

1. Lighting Analysts AGI32
 - a. Radiosity Convergence
 - i. Maximum Step size set to 1000 steps
 - ii. Convergence set to 10% (0.1)
2. Luxicon 2.3.20
3. LitePro 1.02

Room Configurations:

Four room configurations were selected for being typical office spaces. Each space has a different shape and the spaces were selected to have Room Cavity Ratios (RCR) ranging from 1.0 to 7.5 in an attempt to limit any influence RCR might have on the results. The room configurations studied are as follows:

1. 10' x 10' Private Office (RCR = 6.0 to 7.5)
2. 100' x 30' Open Office (RCR = 1.3 to 1.6)
3. 60' x 60' Open Office (RCR = 1.0 to 1.3)
4. Irregular Open Office (RCR = 2.0 to 2.5)

While additional room configurations should be considered with future studies, this study limited the number of room configurations to four to achieve preliminary information on the effects of ceiling reflectance.

Light Fixture Selection Information:

Two different light fixtures were utilised in this study. An indirect pendant and a recessed troffer were selected to view the effects of different photometric distribution types. The fixture selections were as follows:

1. Indirect light fixture
Single T5HO lamp in cross section 5000 initial lumens per lamp (assuming an under floor air system, which allows the room air to stratify and maintain 35 degree C ambient air temperature inside the fixture).
2. 2' x 2' Parabolic Troffer
Two 32W T8 U lamps
3150 initial lumens per lamp.

For information on the exact light fixtures and photometric files used, please see the attached appendix.

Light loss factors are as follows:

| | |
|------------------------------------|--------------|
| a. Room Surface Dirt Depreciation: | 0.89 |
| b. Luminaire Dirt Depreciation: | 0.95 |
| c. Ballast Factor: | 1.00 |
| d. Lamp Lumen Depreciation: | 0.90 |
| Total LLF: | 0.761 |

The Studies

Workplane Illuminance and Ceiling Uniformity Study

Each room configuration was tested with 5 different ceiling heights: 10', 9.75', 9.5', 9.25', and 9', while maintaining a luminaire height of 8.5' from the floor plane. Work plane illuminances were calculated at 2.5' above the floor surface. The ceiling uniformity portion of this study focuses only on the indirect fixture. Ceiling uniformity was calculated within the area above and between luminaires in compliance with IESNA RP-1-2004³ recommendations.

The lighting layout in each room configuration was designed to meet 50 maintained fc using a 75% reflective ceiling tile. In the case of the indirect light fixture, the best possible ceiling uniformity was achieved. It should be noted that at extremely low ceiling heights, the ceiling uniformity did exceed IESNA recommendations. All variables were held constant and only the ceiling tile reflectance was varied up to 90%.

The calculations of work plane illuminance and ceiling uniformity for each fixture type were compared between the varying ceiling reflectances to determine a percentage change achieved with the higher reflectance value of the ceiling tile.

Lighting Layout 1

1. 10' x 10' room:

- a. Indirect – 2 luminaires.

2. 100' x 30' room:

- a. Indirect – 10 rows of 6 luminaires spaced 10 feet apart. Total of 60 luminaires.
- b. Direct – A grid of 12 luminaires spaced 8 feet apart by 4 luminaires spaced 7 feet apart. Total of 48 luminaires.

3. 60' x 60' room:

- a. Indirect – 5 rows of 14 luminaires spaced 12 feet apart. Total of 70 luminaires.
- b. Direct – A grid of 7 luminaires spaced 8 feet apart by 8 luminaires spaced 7 feet apart. Total of 56 luminaires.

4. Irregular room:

- a. Indirect – 8 rows of 9 luminaires spaced 10 feet apart and 4 rows of 10 luminaires spaced 10 feet apart. Total of 112 luminaires.
- b. Direct – A grid of 10 luminaires spaced 8 feet apart by 5 luminaires spaced 8 feet apart, and 5 luminaires spaced 8 feet apart by 5 luminaires spaced 8 feet apart. Total of 75 luminaires.

Results:

For direct fixtures the work plane illuminance achieved modest increases ranging from 2% to 5% when increasing the ceiling reflectance from 75% to 90%.

The High Light Reflectance Ceiling (HLRC) compared to a 75% reflective ceiling achieves an average increase of approximately 22% in work plane illuminance with indirect lighting. This result was very consistent between room shapes and ceiling heights. The results are also very similar to results previously achieved in studies by Penn State University⁸ and by the Weidt Group study⁹.

The ceiling uniformity also improved. In a few instances, calculations showed that switching to a 90% reflective ceiling enabled the ceiling uniformity to come within IESNA RP-1-2004³ recommendations, whereas it did not meet the recommendations with a 75% reflective tile. In the single 10'x10' office, an average of 3.67% improvement in ceiling uniformity was noted, whereas the open office plans had much higher average improvements of roughly 10 - 15%. Taking into account all instances where the layouts with the 90% reflectance ceiling had uniformity ratios within IESNA recommendations of 10:1, the average improvement in the uniformity ratio when switching from the 75% to the 90% reflective ceiling was 6.84%. These results are also very similar to results previously achieved in studies by Zhang & Ngai¹⁰.

This research yields two important results:

1. HLRC ceiling systems show more improvement in larger office plans than single private offices, with ceiling uniformity ratios improving by an average of 12.58% and 3.67%, respectively.
2. HLRC ceiling systems provide an average of approximately 22% increase in work plane illuminance.

Below is a summary chart of the results found in this study.

10' Ceiling Height

Workplane illuminance increased
by an average of 22.64 %

Ceiling uniformity improved by an average of 4.51 %

9'-9" Ceiling Height

Workplane illuminance increased
by an average of 22.76 %

Ceiling uniformity improved by an average of 6.25 %

9'-6" Ceiling Height

Workplane illuminance increased
by an average of 22.54 %

Ceiling uniformity improved by an average of 9.64 %

9'-3" Ceiling Height

Workplane illuminance increased
by an average of 22.87 %

Ceiling uniformity improved by an average of 13.92 %

9' Ceiling Height

Workplane illuminance increased
by an average of 22.86 %

Ceiling uniformity improved by an average of 19.45 %

Note: Not all room and ceiling configurations met the IESNA recommended 10:1 ratio of luminance ratio (max/min). Comparing only the rooms that met 10:1 ratio, ceiling uniformity improved by an average of 6.84 %

Through analysis of the results for a variety of ceiling reflectance values, a nearly linear increase in illuminance levels was found when increasing the ceiling reflectance.

This linear increase does not have a simple equation to apply to all conditions as the slope of the line is dependant on several factors including the room cavity ratio and the fixture's coefficient of utilisation. However, it is interesting to see that, given all factors remain constant within a space except the ceiling reflectance, there is a linear equation for the given room's illuminance increase. The ceiling uniformity also appears to improve in a linear fashion, although due to the decimal point limitations of the calculations the graph is not smooth. Some example graphs are included following.

60'x60'x10 Open Office, 12' Luminaire Spacing

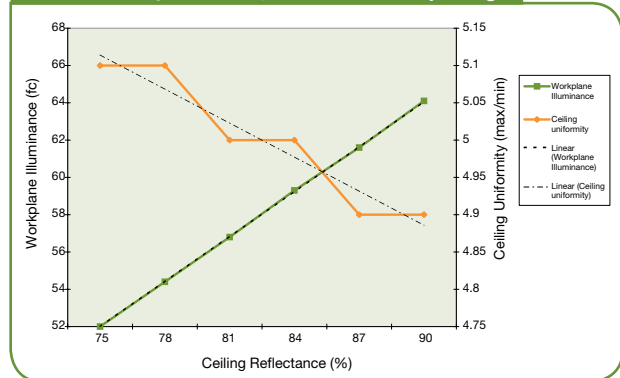

60'x60'x9.5, 12' Luminaire Spacing

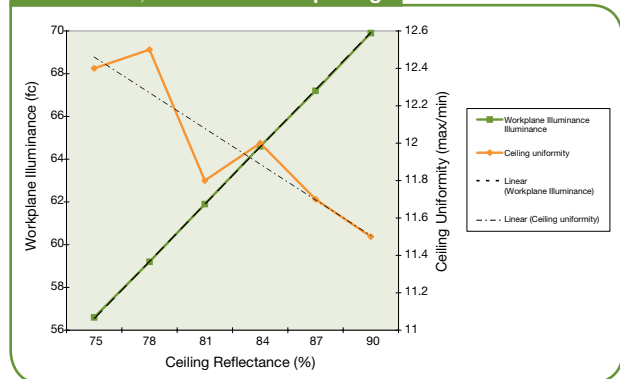

100'x30'x10 Open Office, 10' Luminaire Spacing

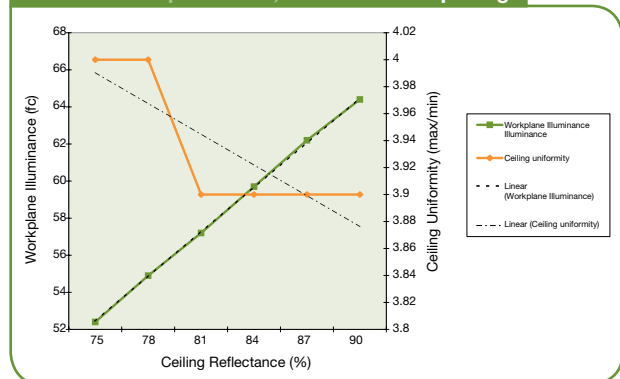

Irregular Open Office, 10' Ceiling Height, 12' Luminaire Spacing

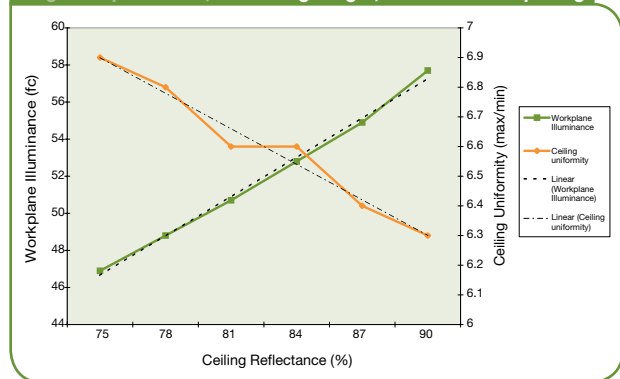

Energy Savings Study

Utilising the same spaces and fixtures as previously defined, a new lighting design was created for the indirect light fixtures to optimise the layout to achieve 50 maintained fc with the 90% reflective ceiling tile with the best possible ceiling uniformity. In all cases the ceiling height was held constant at 10'. Indirect luminaires were mounted at 8.5'. These results were also compared against a typical office layout of 2' x 2' recessed parabolic troffer style luminaires with standard spacing, as shown in the Workplane Illuminance and Ceiling Uniformity Study. All calculations were then compared against each other to determine a percentage change in energy use that was achieved with the higher value for the ceiling tile.

75% reflective ceiling tile - T5HO Indirect

1. 100' x 30' room:

- a. Indirect – Ten rows of 24-foot sections spaced 10 feet apart for a total of 60 luminaires.
- b. Direct - A grid of 12 luminaires spaced 8 feet apart by 4 luminaires spaced 7 feet apart for a total of 48 fixtures.

2. 60' x 60' room:

- a. Indirect – Six parallel rows of three 16-foot sections spaced 10 feet apart side to side and 4 feet apart end to end for a total of 72 luminaires.
- b. Direct – A uniform grid of 56 luminaires spaced on 8 foot centres in one direction and alternating 8 foot and 6 foot spacing in the other direction.

3. Irregular room:

- a. Indirect - Six parallel rows of three 16-foot sections spaced 10 feet apart side to side and 4 feet apart end to end for a total of 96 luminaires total.
- b. Direct – A uniform grid of 75 luminaires spaced out on 8 foot centres.

90% reflective ceiling tile - T5HO Indirect

1. 100' x 30' x 10' room:

- a. Eight rows of 24 foot sections spaced 12 feet apart for a total of 48 luminaires.
- b. Direct - A grid of 12 luminaires spaced 8 feet apart by 4 luminaires spaced 7 feet apart for a total of 48 luminaires.

2. 60' x 60' x 10' room:

- a. Four parallel rows of three 16-foot sections spaced 13 feet apart side to side and 4 feet apart end to end for a total of 60 luminaires.
- b. Direct – A uniform grid of 56 luminaires spaced on 8 foot centres in one direction and alternating 8 foot and 6 foot spacing in the other direction.

3. Irregular room:

- a. 16-foot sections spaced 12 feet apart side to side and 4 feet apart end to end for a total of 72 luminaires.
- b. Direct – A uniform grid of 75 luminaires spaced out on 8 foot centres.

Results:

Using the 90% reflective ceiling allowed the spacing between indirect luminaire sections to be increased, which reduced the total number of luminaires needed to achieve light levels similar to the 75% reflective ceiling. When changing from a 75% to 90% reflective ceiling tile utilising direct fixtures there was a slight increase in light levels, but not a large enough increase to allow for the reduction of fixtures. As such, the layouts for all ceiling reflectances remained the same for the direct fixtures. For the 100' x 30' x 10' room, utilising the HLRC allowed a reduction of the lighting power density to 0.96 watts per square foot (w/ft²), which is 20% better than a 75% reflective ceiling. This yields a savings of 0.24 w/ft², or a reduction in cooling load of 20% over a standard 75% reflective ceiling. This is also a reduction of 0.16 w/ft² as compared to using 2' x 2' parabolic luminaires, which results in a reduction in cooling load by 14.29%. The 60' x 60' x 10' room shows similar results. Moving from the 75% reflective tile with a 10' spacing to the 90% reflective tile with a 13' spacing resulted in work plane illuminances of 52.9fc compared to 51.7fc and ceiling uniformities of 6:1 and 7.4:1 respectively, which is within the IESNA RP-1-20043 recommendation of 10:1.

Utilising a 13' spacing allowed the deletion of one entire row of lights, dropping the power density to 1.00 w/ft². This yields a savings of 0.17 w/ft², or a reduction in cooling load due to lighting of 14.29% as compared to the 10' spacing with 75% reflective ceiling. When compared to the 2' x 2' parabolic troffer, the cooling load energy savings rose to 31.43% when the recessed system achieved an average work plane illuminance of 54.3fc.

Below is a summary of the average power density reductions achieved when changing the ceiling reflectance from 75% to 90%:

The optimised layout with HLRC and indirect luminaires yielded a:

23.33% lower average power density over the standard 75% reflective ceiling layout (Layout 2).

21.14% lower average power density over the standard 2' x 2' parabolic troffer layout (Layout 4).

The breakdown is as follows:

| | | |
|------------|--------|---|
| 100' x 30' | 20.00% | better than the standard layout with 75% reflective ceiling |
| | 14.29% | better than the 2' x 2' layout with 75% or 90% reflective ceiling |
| 60' x 60' | 14.29% | better than the standard layout with 75% reflective ceiling |
| | 31.43% | better than the 2' x 2' layout with 75% or 90% reflective ceiling |
| Irregular | 35.71% | better than the standard layout with 75% reflective ceiling |
| | 17.71% | better than the 2' x 2' layout with 75% or 90% reflective ceiling |

HVAC Savings Study

Using the three open office room configurations previously defined, the effects of the reduced lighting load on the HVAC system was modeled using two different computer software programs. The building was assumed to be located in Atlanta, Georgia. Each model was run once with northern facing windows and once with southern facing windows for relative heat gain and loss only, as no daylight dimming was considered. The open offices were assumed to be located on an intermediate floor, where losses and gains due to the roof or floor structure are negligible. The wall structure was assumed to have a U-value of 0.094 btu/hr/sf/oF and be of standard ASHRAE 90.1-20045 configuration. The power densities used in each iteration were developed in the previous portion of this study. A detailed occupancy schedule can be found in the attached appendix under "scheduled hours of operation." In general the office was considered occupied from 6:00 am to 6:00 pm daily during the week and unoccupied on weekends and holidays. In the unoccupied mode some lights and equipment were considered "on" to account for late employees, cleaning or maintenance crews, security, etc.

Software Used:

1. DOE2
2. Trane Tracer

Results:

The results obtained from modeling the lighting and HVAC in Trane Tracer as it relates to heating and cooling loads showed roughly a 7% decrease in energy consumption with the indirect fixtures and 90% reflective ceiling, as compared to the 75% reflective ceiling or the 2x2 troffer layout on either ceiling. DOE2 showed similar results, although slightly lower savings. Due to the makeup of the building envelope, the internal heat gains kept the cooling system in operation year round. We predict that this is greatly dependant on climate. In cold climates, because of the decrease in watts used by the lighting system, the heating system will use more energy to compensate. For warm climates, the reduction in light power density will allow the cooling system to use less energy, holding all other variables the same.

Summary results of the study are shown below:

The reduction in lighting power density obtained by the 90% reflective ceiling enabled an average HVAC energy cost savings of:

North Facing Facade

9.10% over the layout with a 75% reflective ceiling
7.40% over the 2 x 2 troffer layout

South Facing Facade

7.80% over the layout with a 75% reflective ceiling
6.60% over the 2 x 2 troffer layout

Summary:

Based on the results of this limited study, there does appear to be a significant impact on the HVAC system from reducing the lighting load through the use of an HLRC. This impact can be positive in the form of energy savings if the building is in cooling year-round, as many large scale commercial buildings are. Even buildings that experience heating loads often only experience those loads at the perimeter and could still see overall positive impacts from the lighting savings. In buildings where the heating load is significant, the reduction of lighting will increase the HVAC system costs due to the additional heating load. It should be noted that even in this condition, the lighting savings significantly offset this additional heating cost.

LEED Credit Analysis Version 2.1 projects registered prior to 2006:

HLRC has proven to reduce the lighting power density by over 20% as compared to a typical 75% reflective ceiling using the same lighting system, while having a positive impact on the HVAC systems in buildings that are mostly in cooling. To relate this to the LEED point system, it is necessary to look at lighting power densities rather than percentage reductions, as in previous portions of this study. LEED NC 2.16 refers to ASHRAE 90.1-19994 as the base model of energy use and then applies credits for a reduction in total building power to that specified limit.

The specified lighting power density limit for open office areas is 1.3 w/ft². The average power densities achieved for this study are listed in the graph below and compared to the ASHRAE 90.1-19994 limit as a percentage saved.

The Energy Information Administration (EIA)11, which administers the official energy statistics for the United States Government through the Department of Energy (DOE), states that about 35% of a typical U.S. office building's energy is used in equipment and other energy using devices (see the graphs below). While these internal loads were included in the HVAC calculations for this study for heat gain purposes, they remained the same in all conditions since this study is limiting the variables to the ceiling reflectance only and associated

lighting improvements only. The LEED point system is only affected by the total building energy for HVAC (heating, cooling, fans, and pumps), service hot water, and interior lighting, and thus, we can disregard the equipment and other energy users. According to the EIA11 statistics, HVAC accounts for 63% and lighting accounts for 34% of the remaining energy used in U.S. office buildings.

Percent of energy used by US office buildings according to the Energy Information Administration¹¹

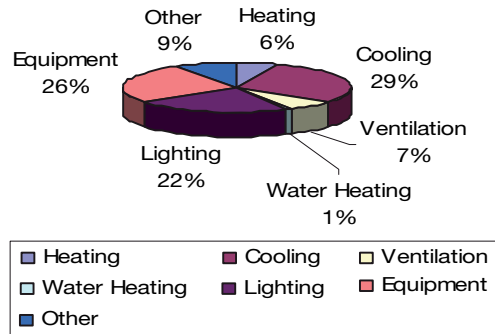

Percent of energy used by US office buildings related to LEED NC version 2.16 energy calculations according to the Energy Information Administration¹¹

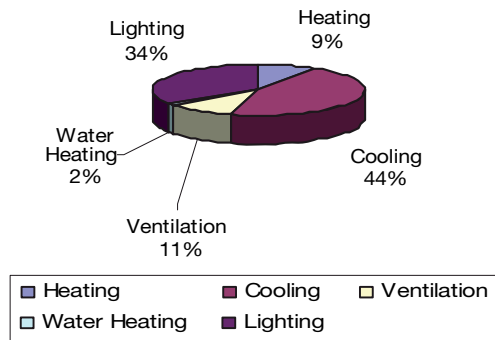

Percentage energy savings compared to ASHRAE 90.1-1999⁴

| | |
|--|-------|
| Indirect Layout with 75% Reflective Ceiling | |
| Percent Saving Lighting | 2.3% |
| Percent Saving HVAC | 0.9% |
| Total Percent Energy | 1.8% |
| Maximized Indirect Layout with 90% Reflective Ceiling | |
| Percent Saving Lighting | 27.4% |
| Percent Saving HVAC | 11.0% |
| Total Percent Energy | 21.6% |
| 2x2 Parabolic Troffer Layout | |
| Percent Saving Lighting | 6.9% |
| Percent Saving HVAC | 2.8% |
| Total Percent Energy | 5.5% |

Summary:

Based on the spaces used for this study, high light reflectance ceilings do have an impact on LEED points. In this limited study, additional energy points were achieved through nothing more than increasing the ceiling reflectance. The total building energy savings as defined by LEED NC version 2.1⁶ could be as high as 21.6% when optimising the lighting layout with respect to the HLRC. This savings qualifies for up to 2 points in a new building or 4 points in an existing building.

LEED Credit Analysis Version 2.2 projects registered after to 2006:

The pure energy savings in comparing LEED NC version 2.2⁷ are very similar to those used in LEED NC version 2.1⁶. The biggest difference in regards to the Energy and Atmosphere credit for Optimised Energy is that version 2.2⁷ refers to ASHRAE 90.1-2004⁵ whereas version 2.1⁶ refers to ASHRAE 90.1-1999⁴. As a result, credits become more difficult to achieve because energy restrictions in ASHRAE 90.1-2004⁴ are tighter. For example, the specified lighting power density specified limit for office areas was reduced from 1.3 to 1.1 w/ft². The point structure also changed slightly.

Under LEED NC version 2.1⁶, a minimum reduction of 15% for new buildings and 5% for existing buildings was required to achieve the first point and then an additional point was given for every 5% additional savings beyond that. In LEED NC version 2.2⁷, the first point is achieved at a reduction of 10.5% for new buildings and 3.5% for existing buildings and then an additional point is earned for each additional 3.5% savings achieved. The net result is stricter energy guidelines, but a slightly easier point system.

The average power densities achieved for this study are listed in the graph below and compared to the ASHRAE 90.1-2004⁵ limit as a percentage saved.

Indirect Layout with 75% Reflective Ceiling

| | | |
|-------------------------|------------------|-------|
| Percent Saving Lighting | Misses target by | 5.6% |
| Percent Saving HVAC | Misses target by | 5.6% |
| Total Percent Energy | Misses target by | 11.8% |

Maximized Indirect Layout with 90% Reflective Ceiling

| | | |
|-------------------------|-----------------|-------|
| Percent Saving Lighting | Beats target by | 14.1% |
| Percent Saving HVAC | Beats target by | 5.1% |
| Total Percent Energy | Beats target by | 10.6% |

2 x 2 Parabolic Troffer Layout

| | | |
|-------------------------|------------------|-------|
| Percent Saving Lighting | Misses target by | 10.2% |
| Percent Saving HVAC | Misses target by | 3.6% |
| Total Percent Energy | Misses target by | 7.7% |

Percentage energy savings compared to ASHRAE 90.1-20044

Summary:

Based on the spaces used for this study, high light reflectance ceilings do have an impact on LEED points. In this limited study, additional energy points were achieved through nothing more than increasing the ceiling reflectance. The total building energy savings as defined by LEED NC version 2.2⁷ could be as high as 10.6% when optimising the lighting layout with respect to the HLRC. This savings qualifies for up to 1 point in a new building or 3 points in an existing building.

Discussion:

This study focuses primarily on the effects that increasing ceiling reflectance has on illuminance levels, uniformity ratios, and building energy use. While the study attempts to take a wide variety of space configurations into account, the study is still very limited in scope and thus, only general conclusions can be drawn.

Partitions and office furniture were not included in the calculations for this study.

As shown in previous studies, such as those by Choi and Mistrick¹², office partition colour and style can have a significant impact on the lighting systems. Because this study is focused on the ceiling reflectance, the office partitions would have remained constant among all iterations and thus, the results should not be significantly different in terms of percentage increase or decrease had they been included.

As previously noted, the HVAC savings will vary considerably dependant on location. Further investigation on the impact of lighting to HVAC costs should be conducted, as this study hinted toward a decrease in lighting load having a negative impact on HVAC costs when heating loads are high, although total building energy was still decreased.

Additional energy savings could be obtained through further optimisation in the design by selecting a variety of fixtures, optics, ballast types, etc. These options were not considered, to maintain the consistency of evaluating the effects of the ceiling reflectance. Daylighting was also intentionally left out of this study but should be considered. The effects of daylight with high reflectance ceilings could add significant cost savings to the building, particularly when dimming is considered. Evaluation of these additional factors will not be easy due to the large number of variables to deal with, but initial research seems to be warranted.

As stated in the introduction, this study used 50 maintained fc average as the target work plane illuminance per IESNA recommendations for private offices or open office plans with intermittent VDT use. Additional energy reductions could be achieved through the use of a task/ambient lighting system where the ambient system only targets 30 fc. While further research is suggested, this study did not look at the effect of high reflectance ceilings at light levels other than 50 fc.

Overall Summary

In general, increasing the reflectance of the ceiling has a very positive impact on the lighting and building energy use as a whole, particularly relative to indirect lighting designs. The following conclusions can be made when increasing the ceiling reflectance from 75% to 90%:

- The illuminance levels for the same lighting design increase in a linear fashion up to 22%.
- The ceiling uniformity improves in a linear fashion.
- The ceiling uniformity improves by a greater percentage as the distance between the ceiling and the luminaire is reduced.
- An average reduction in lighting energy of over 20% can be achieved, however this is widely dependant on the space configuration.
- The building's cooling system can see an average savings of 7%.
- The total building energy consumption (as calculated by LEED NC version 2.1⁶) can be reduced by 16 to 19 percent.
- 2 to 4 LEED NC version 2.16 points can be achieved for the energy reduction point for new or existing construction, respectively.
- 1 to 3 LEED NC version 2.2⁷ points can be achieved for the energy reduction point for new or existing construction, respectively.

It should be recognised that each building and situation is very unique and this study in no way claims that increasing the reflectance of the ceiling system will ensure any specific energy savings or LEED points. However, the indications are that lighting designers and architects should be looking at the ceiling system as an integral portion of the building's energy reduction techniques. The overall cost impact to potential energy savings may make high reflectance ceilings a good solution for achieving energy reductions without the need for expensive new technology.

References:

- 1) Energy Policy Act of 2005 Section 1331, Pub. L. No. 109-58, 119 Stat. 594 (2005).
- 2) ANSI/ASHRAE/IESNA Standard 90.1-2001 – Energy Standard for Buildings Except Low-Rise Residential Buildings I-P Edition.
- 3) Illuminating Engineering Society of North America – Recommended Practices 1, 2004 (RP-1-2004). American National Standard Practice for Office Lighting.
- 4) ANSI/ASHRAE/IESNA Standard 90.1-1999 – Energy Standard for Buildings Except Low-Rise Residential Buildings I-P Edition.
- 5) ANSI/ASHRAE/IESNA Standard 90.1-2004 – Energy Standard for Buildings Except Low-Rise Residential Buildings I-P Edition.
- 6) United States Green Building Council, 2002 LEED NC Green Building Rating System version 2.1.
- 7) United States Green Building Council, 2005 LEED NC Green Building Rating System version 2.2.
- 8) Penn State University, 2005. Influences of Ceiling and Wall Reflectance on Daylight Factors and Power Densities for a Classroom.
- 9) Weidt Group, 1996. Performance Benefits of High Reflectance Ceilings.
- 10) Zhang, J., and Ngai, P. 1998. Ceiling Luminance Ratios for Linear Fluorescent Indirect Luminaires. "Journal of the IES". 27(1):85-91.
- 11) Department of Energy, Energy Information Administration - Official Energy Statistics of the United States Government. Form EIA-871A-F, "Commercial Buildings Energy Consumption Survey." Found at <http://www.eia.doe.gov/emeu/cbecs>
- 12) Choi, A.S., and Mistrick, R.G., 1995. A Study of Lighting System Performance in Partitioned Spaces. "Journal of the IES". 24(2):50-63.

Appendix Contents

- A1.** Linear Indirect Pendant Product Data - Peerless Lighting Lightfin Diminutive Indirect, Single T5HO lamp in cross section, 5000 initial lumens per lamp (assuming an under floor air system, which allows the room air to stratify and maintain 35 degree C ambient air temperature inside the fixture)
- A2.** 2 x 2 Troffer Product Data - 2' x 2' Lithonia Paramax Parabolic Troffer, Two 32W T8 U lamps, 3150 initial lumens per lamp
- A3.** Manufacturer Data Sheet for the 75% reflective ceiling tile – Armstrong World Industries, Optima Open Plan Series
- A4.** Manufacturer Data Sheet for the 90% reflective ceiling tile – Armstrong World Industries, Random Fissured Series
- A5.** Ceiling and Work Plane Illuminance Calculation Summary of Luxicon 2.3.20
- A6.** Ceiling and Work Plane Illuminance Calculation Summary of Lighting Analysts AGI32
- A7.** Ceiling and Work Plane Illuminance Calculation Summary of LitePro 1.02
- A8.** Lighting Energy Analysis Spreadsheet
- A9.** Lighting Power Density Spreadsheet
- A10.** Graphs of Illuminance and Ceiling Uniformity vs. Ceiling Reflectance
- A11.** Energy Model Results Summary

LIGHTFIN[®] DIMINUTIVE INDIRECT

PEERLESS[®]

6" X 2" Angular

PENDANT MOUNT - MODULAR

SPECIFICATIONS

AVAILABLE FIXTURES

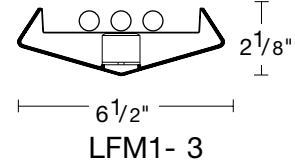
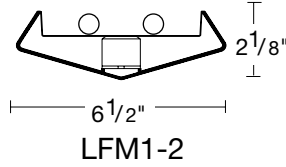
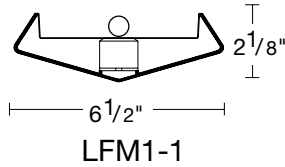

SPECIFICATIONS

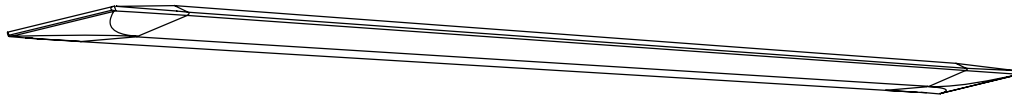

CONSTRUCTION

Housing AA 6063 T6 extruded aluminum forming a 6 1/2" x 2 1/8" angular channel. Die-cast end plate attaches with no exposed fasteners.

REFLECTORS

Die-formed reflectors combine hammertone specular aluminum and baked white enamel (nominal reflectance 86%).

FINISH

Satin anodised or white paint standard; custom colours available.

ELECTRICAL

Specify 120 volt or 277 volt. Pre-wired with prescribed circuits and are UL listed. Listed and labeled to comply with Canadian standards. For special circuiting, consult factory. T5 high-output lamps are included.

FIXTURE LENGTH

4', 8', and 12' lengths in a single section for exact suspension spacing of 4', 8', and 12'. For total fixture length add 4-1/2" for each end-cap. Using internal joiners, 4', 8', and 12' sections can be joined to form longer-length fixtures.

ORDERING LOGIC

Use guide below to order complete fixture runs from four feet to three-hundred feet in increments of four.

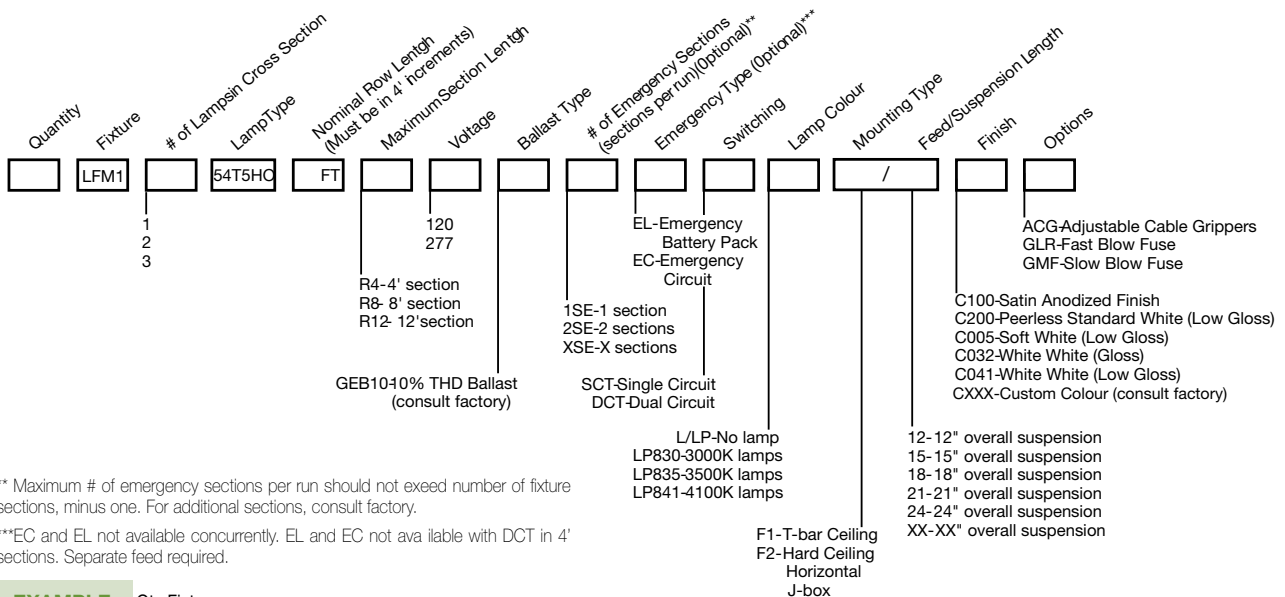

** Maximum # of emergency sections per run should not exceed number of fixture sections, minus one. For additional sections, consult factory.

***EC and EL not available concurrently. EL and EC not available with DCT in 4' sections. Separate feed required.

EXAMPLE Qty Fixture:

- 4 LFM1 1 54T5HO 40FT R12 120 GEB 2SE EL SCT LP 835 F1/24 C005
- 2 LFM1 2 54T5HO 32FT R8 120 GDIM DCT LP830 F1/12 C200 GLR

LIGHTFIN® DIMINUTIVE INDIRECT

PEERLESS®

6" X 2" Angular

PENDANT MOUNT - MODULAR

PHOTOMETRICS

1-LAMP T5 HIGH-OUTPUT

FAR-FIELD PHOTOMETRY
REPORT NUMBER: 4507 DATE: 10-1-1999

CATALOG NUMBER: LFM1-1-54T5HO
LUMINAIRE: 6" W X 2" H EXTRUDED ALUMINUM INDIRECT LIGHT WITH WHITE PAINTED AND HAMMERTONE REFLECTOR
LAMP(S): FP54/835/HO RATED @ 5000 LUMENS
BALLAST: QT 1X54/120PHO
MOUNTING:
LUMEN TO CANDELA RATIO USED = 9,15
TOTAL INPUT WATTS = 60,5 AT 120,0 VOLTS
THE 0 DEGREE PLANE IS PARALLEL WITH THE LAMPS.

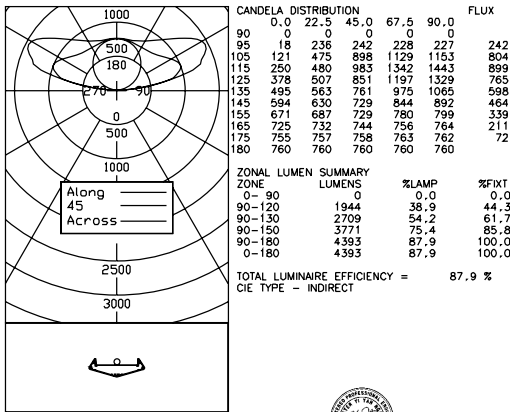

APPROVED BY:



TESTED IN ACCORDANCE WITH IES PROCEDURES, TEST DISTANCE EXCEEDS 25.0 FEET NEAR-FIELD PHOTOMETRY AND CU TABLE AVAILABLE UPON REQUEST

2-LAMP T5 HIGH-OUTPUT

FAR-FIELD PHOTOMETRY
REPORT NUMBER: 4508 DATE: 10-1-1999

CATALOG NUMBER: LFM1-2-54T5HO
LUMINAIRE: 6" W X 2" H EXTRUDED ALUMINUM INDIRECT LIGHT WITH WHITE PAINTED AND HAMMERTONE REFLECTOR
LAMP(S): 2-FP54/835/HO RATED @ 5000 LUMENS EACH
BALLAST: QT 2X54/120PHO
MOUNTING:
LUMEN TO CANDELA RATIO USED = 9,15
TOTAL INPUT WATTS = 120,4 AT 120,0 VOLTS
THE 0 DEGREE PLANE IS PARALLEL WITH THE LAMPS.

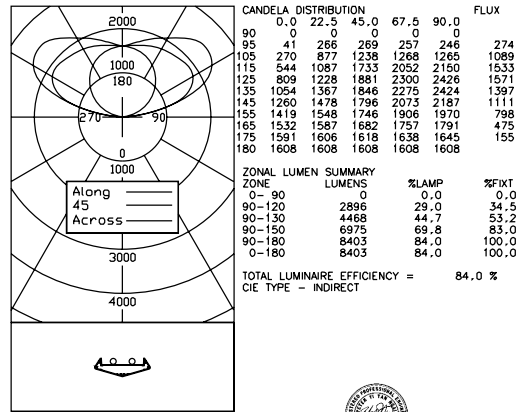

APPROVED BY:



TESTED IN ACCORDANCE WITH IES PROCEDURES, TEST DISTANCE EXCEEDS 25.0 FEET NEAR-FIELD PHOTOMETRY AND CU TABLE AVAILABLE UPON REQUEST

3-LAMP T5-HIGH OUTPUT

FAR-FIELD PHOTOMETRY
REPORT NUMBER: 4509 DATE: 10-1-1999

CATALOG NUMBER: LFM1-3-54T5HO
LUMINAIRE: 6" W X 2" H ALUMINUM INDIRECT LIGHT WITH WHITE PAINTED AND HAMMERTONE REFLECTOR
LAMP(S): 3-FP54/835/HO RATED @ 5000 LUMENS EACH
BALLAST: QT 1X54/120PHO & 2X54/120PHO
MOUNTING:
LUMEN TO CANDELA RATIO USED = 9,15
TOTAL INPUT WATTS = 180,9 AT 120,0 VOLTS
THE 0 DEGREE PLANE IS PARALLEL WITH THE LAMPS.

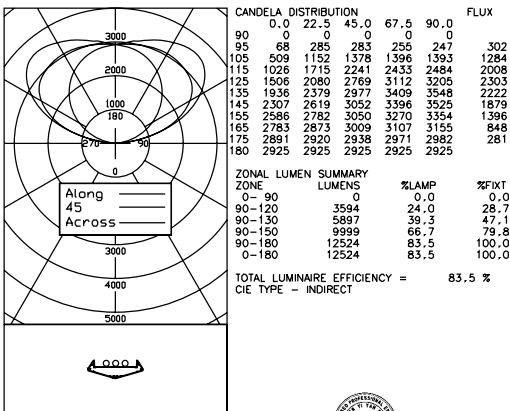

APPROVED BY:



TESTED IN ACCORDANCE WITH IES PROCEDURES, TEST DISTANCE EXCEEDS 25.0 FEET NEAR-FIELD PHOTOMETRY AND CU TABLE AVAILABLE UPON REQUEST

PERFORMANCE SUMMARIES

1-LAMP

| | | |
|-----------------------|-------------|-----|
| % Luminaire | 90° - 120° | 44% |
| Lumens from | 90° - 130° | 61% |
| | 90° - 150° | 85% |
| Maximum Flux Location | 110° - 120° | |
| Luminaire Efficiency | 87% | |

2-LAMP

| | | |
|-----------------------|-------------|-----|
| % Luminaire | 90° - 120° | 34% |
| Lumens from | 90° - 130° | 53% |
| | 90° - 150° | 83% |
| Maximum Flux Location | 120° - 130° | |
| Luminaire Efficiency | 84% | |

3-LAMP

| | | |
|-----------------------|-------------|-----|
| % Luminaire | 90° - 120° | 28% |
| Lumens from | 90° - 130° | 47% |
| | 90° - 150° | 79% |
| Maximum Flux Location | 120° - 130° | |
| Luminaire Efficiency | 83% | |

FEATURES

- Full family of parabolic luminaires with 3-inch-deep louvers.
- Models available to meet IES RP-1 minimum luminance criteria for office lighting systems in VDT applications. Optimax products are available to meet preferred criteria.
- Choice of low iridescent diffuse or specular louver finishes. Also available with new Achroma™ non-iridescent louver finish.
- Black reveal provides floating louver appearance, conceals optional air-supply slots.
- Overlapping flange and modular ceiling trims are factory-installed with standard swing-gate hangers or field-convertible with optional trim and hanger kits.
- Optional heat-removal dampers and air-pattern control blades allow airflow control.
- T-hinges are die-formed for maximum strength. Latches are spring-loaded and concealed in reveal.
- Guaranteed for one year against mechanical defects in manufacture.

PARAMAX® Parabolic Troffer

PM3 2'x2'

**3" Deep Louver
6" Wide U Lamps
2 Lamps**

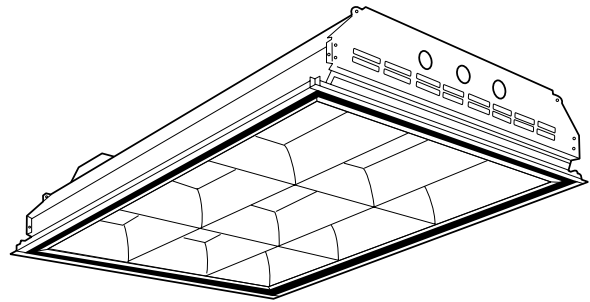

SPECIFICATIONS

BALLAST — Thermally-protected, resetting, Class P, HPF, non-PCB, UL listed, CSA certified ballast is standard. Energy-saving and electronic ballasts are sound rated A. Standard combinations are CBM approved and conform to UL 935.

WIRING & ELECTRICAL — Fixture conforms to UL 1570 and is suitable for damp locations. AWM, TFN or THHN wire used throughout, rated for required temperatures.

MATERIALS — Housing formed from cold-rolled steel. Louvers formed from premium-grade aluminum lighting sheet. No asbestos is used in this product.

FINISH — Five-stage iron-phosphate pretreatment ensures superior paint adhesion and rust resistance. Painted parts finished with high-gloss, baked white enamel.

LISTING — UL listed and labeled. Listed and labeled to comply with Canadian and Mexican Standards (see Options).

Specifications subject to change without notice.

PHOTOMETRICS

Calculated using the zonal cavity method in accordance with IESNA LM41 procedures. Floor reflectances are 20%. Lamp configurations shown are typical. Full photometric data on these and other configurations available upon request.

2PM3 G B 2 U40 9LD

Report LTL 4452 - Lumens per lamp = 2935

S/MH (along) 1.2 (across) 1.5

Coefficient of Utilisation

| Ceiling | 80% | | | 70% | | | 50% | | | 0% |
|---------|-----|-----|-----|-----|-----|-----|-----|-----|----|----|
| | 70% | 50% | 30% | 50% | 30% | 50% | 30% | 10% | | |
| 0 | 70 | 70 | 70 | 69 | 69 | 69 | 66 | 66 | 66 | 59 |
| 1 | 66 | 64 | 62 | 65 | 63 | 61 | 60 | 59 | 58 | 53 |
| 2 | 62 | 58 | 55 | 60 | 57 | 54 | 55 | 52 | 50 | 47 |
| 3 | 57 | 52 | 48 | 56 | 51 | 48 | 50 | 47 | 44 | 41 |
| 4 | 53 | 47 | 42 | 51 | 46 | 42 | 45 | 41 | 38 | 36 |
| 5 | 48 | 42 | 37 | 47 | 41 | 37 | 40 | 36 | 33 | 31 |
| 6 | 45 | 38 | 33 | 44 | 37 | 33 | 36 | 32 | 28 | 27 |
| 7 | 41 | 34 | 29 | 40 | 33 | 29 | 32 | 28 | 25 | 24 |
| 8 | 38 | 30 | 25 | 37 | 30 | 25 | 29 | 25 | 22 | 20 |
| 9 | 35 | 27 | 22 | 34 | 26 | 22 | 26 | 22 | 19 | 18 |
| 10 | 32 | 24 | 20 | 31 | 24 | 20 | 23 | 19 | 16 | 15 |

Zonal Lumens Summary

| Zone | Lumens | %Lamp | %Fixture |
|--------|--------|-------|----------|
| 0-30 | 1098 | 18.7 | 31.6 |
| 0-40 | 1857 | 31.6 | 53.4 |
| 0-60 | 3257 | 55.5 | 93.7 |
| 0-90 | 3476 | 59.2 | 100.0 |
| 90-180 | 0 | 0 | 0 |
| 0-180 | 3476 | 59.2 | 100.0 |

2PM3 G B 2 U316 9LD

Report LTL 5466 - Lumens per lamp = 2600

S/MH (along) 1.2 (across) 1.5

Coefficient of Utilisation

| Ceiling | 80% | | | 70% | | | 50% | | | 0% |
|---------|-----|-----|-----|-----|-----|-----|-----|-----|----|----|
| | 70% | 50% | 30% | 50% | 30% | 50% | 30% | 10% | | |
| 0 | 76 | 76 | 76 | 75 | 75 | 75 | 71 | 71 | 71 | 64 |
| 1 | 71 | 69 | 67 | 70 | 68 | 66 | 65 | 64 | 62 | 57 |
| 2 | 67 | 62 | 59 | 65 | 61 | 58 | 59 | 57 | 54 | 51 |
| 3 | 62 | 56 | 52 | 60 | 55 | 51 | 54 | 50 | 47 | 45 |
| 4 | 57 | 51 | 46 | 56 | 50 | 45 | 48 | 44 | 41 | 39 |
| 5 | 52 | 45 | 40 | 51 | 45 | 40 | 43 | 39 | 36 | 34 |
| 6 | 48 | 41 | 36 | 47 | 40 | 35 | 39 | 35 | 31 | 30 |
| 7 | 45 | 37 | 31 | 44 | 36 | 31 | 35 | 31 | 27 | 26 |
| 8 | 41 | 33 | 28 | 40 | 32 | 27 | 31 | 27 | 24 | 22 |
| 9 | 38 | 29 | 24 | 37 | 29 | 24 | 28 | 24 | 21 | 19 |
| 10 | 35 | 27 | 22 | 34 | 26 | 21 | 26 | 21 | 18 | 17 |

Zonal Lumens Summary

| Zone | Lumens | %Lamp | %Fixture |
|--------|--------|-------|----------|
| 0-30 | 1077 | 20.7 | 32.3 |
| 0-40 | 1819 | 35.0 | 54.6 |
| 0-60 | 3083 | 59.3 | 92.5 |
| 0-90 | 3332 | 64.1 | 100.0 |
| 90-180 | 0 | 0 | 0 |
| 0-180 | 3332 | 64.1 | 100.0 |

PM3 2'x2' 6" U lamps, 3" Louver Family, Paramax

MOUNTING DATA

Continuous row mounting of flanged units requires CRE and CRM trim options (see Options).

| Ceiling Type | Appropriate Trim Type |
|---|-----------------------|
| Exposed grid tee | G |
| Concealed grid tee | G, ST |
| Concealed Z-spline | F, MT |
| Metal pan (consult factory) | MT |
| Screw slot (consult factory) | ST |
| Acoustical tile, plaster or plasterboard on rigid support parallel to lamps | F |

NOTE:

1 Recommended rough-in dimensions for F trim fixtures 24" x 24" (Tolerance is +1/4", -0"). Swing-gate range 1" to 4-3/16", span 23-1/2" to 26-5/16".

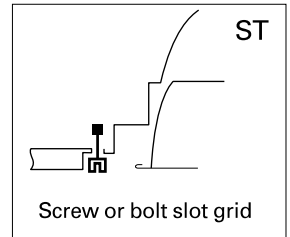
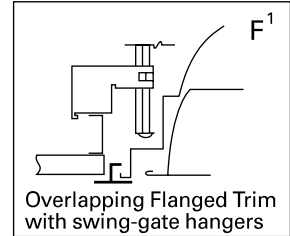
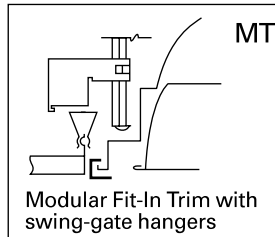
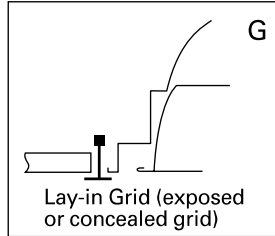

DIMENSIONS

Inches (millimeters). Subject to change without notice.

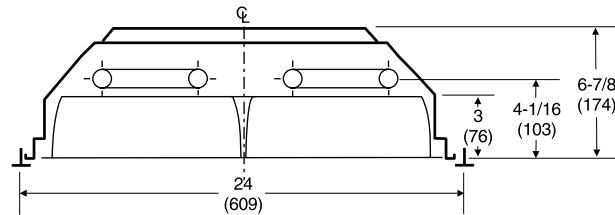

ORDERING INFORMATION

Example: **2PM3 G B 2 U316 9LD 120 GEB**

| 2PM3 | | 2 | | Voltage | | Options | |
|---|---|--|---------------------------|---------------------|--|---|--|
| Series | Air function | Lamp type | Number of lamps | Number of cells | Louver finish | | |
| 2PM3 Paramax parabolic with 3" deep cells, 2' wide | A Air supply/return (slots in side trim) H Heat removal (through lamp cavity, dampers available) D Combination A & H B Static (no air function, matching appearance) | U316 31W T8 (6" leg spacing) U40 40W T12 (6" leg spacing) | 2 Not included. | 6, 9, 12, 16 | ND Achroma™ non-iridescent diffuse silver LD Low iridescent anodized diffuse silver LS Low iridescent anodized specular silver C Diffuse gold anodized (champagne) G Specular gold anodized | 120, 277, 347, MVOLT1 Others available. | GEB Electronic ballast, ≤20% THD GEB10IS Electronic ballast, ≤10% THD, Instant Start GEB10RS Electronic ballast, ≤10% THD, Rapid Start EL Emergency battery pack (nominal 300 lumens; see Life Safety Section); may increase fixture depth LST Tandem fixture pairs (shared ballasts) PWS1836 6' prewire, 3/8" dia., 18-gauge, 3 wires GLR Internal fast-blow fuse GMF Internal slow-blow fuse LP Lamped (specify lamp type and colour) HRD Heat-removal dampers APB Air-pattern control blades (A & D models only) ACS Air closure strips (A & D models only) PAF Painted after fabrication (white enamel) CRE Flanged trim for continuous row mounting (end) CRM Flanged trim for continuous row mounting (middle) 1C One internal channel cover ² CSA Listed and labeled to comply with Canadian Standards NOM Listed and labeled to comply with Mexican Standards JP16 Palletised and stretch-wrapped (16 per), G and MT trim only |
| Trim type | | | | | | | |
| G Grid F Overlapping flanged MT Modular fit-in ST Screw slot | | | | | | | |

NOTES:

1 MVOLT available with GEB10IS only.
2 Option places wireway cover between the two lamps and decreases overall fixture height by approximately 1".

Random Fissured

DESCRIPTION



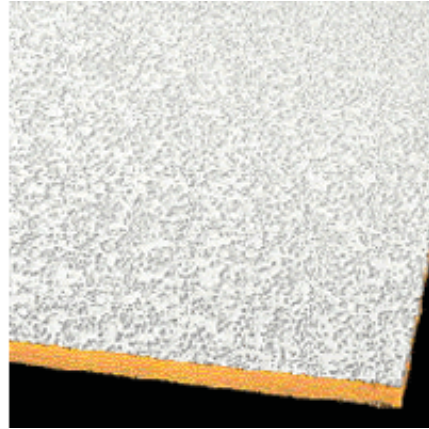

Random Fissured is a popular vinyl faced fine-textured panel with excellent acoustical Performance (perforated).

Easy-clean surface is impact and soil resistant and scrubbable. HumiGuard Plus no sag performance.



PERFORMANCE



| Item # | Edge Profile/ Grid Face | Dimensions | Colour | NRC | CAC/ AC | Fire Performance | Humidity Resist | Light Reflectance (LR) |
|-----------------------|---|--|--------|------|---------|---------------------|--------------------|---------------------------|
| 2908 SAMPLE | Square Lay-In 15/16 IN | 24 x 24 x 5 8 IN  | White | 0.70 | NA / NA | Class A (UL) | HumiGuard Plus | 0.72 |
| 2909 SAMPLE | Square Lay-In 15/16 IN | 24 x 24 x 5 8 IN  | White | 0.55 | NA / NA | Class A (UL) | HumiGuard Plus | 0.72 |
| 2910 SAMPLE | Square Lay-In 15/16 IN | 24 x 48 x 5 8 IN  | White | 0.70 | NA / NA | Class A (UL) | HumiGuard Plus | 0.72 |
| 2911 SAMPLE | Square Lay-In 15/16 IN | 24 x 48 x 5 8 IN  | White | 0.55 | NA / NA | Class A (UL) | HumiGuard Plus | 0.72 |

Optima Open Plan

DESCRIPTION

Fine-textured Optima with nondirectional DuraBrite surface provides excellent acoustics, light reflectance and durability, including impact, scratch and soil resistance, plus washability. HumiGuard Plus no sag performance. In square and plank.

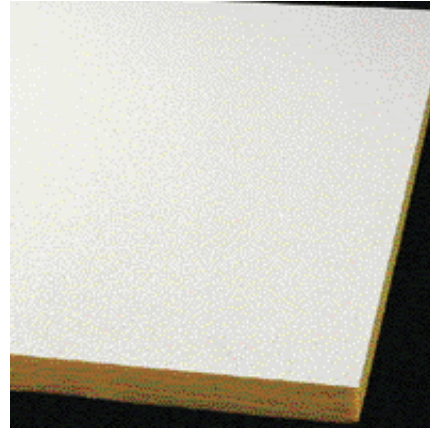

PERFORMANCE



| Item # | Edge Profile/ Grid Face | Dimensions | Color | NRC | CAC/ AC | Fire Performance | Humidity Resist | Light Reflectance (LR) |
|-----------------------|---|---------------------------|-------|------|----------|---------------------|--------------------|---------------------------|
| 3150 SAMPLE | Square Lay-In 15/16 IN | 24 x 24 x 3 4 IN | White | 0.90 | NA /180 | Class A (UL) | HumiGuard Plus | 0.90 |
| 3151 SAMPLE | Square Lay-In 15/16 IN | 24 x 48 x 3 4 IN | White | 0.90 | NA /180 | Class A (UL) | HumiGuard Plus | 0.90 |
| 3152 SAMPLE | Square Lay-In 15/16 IN | 24 x 24 x 1 IN | White | 0.95 | NA /190 | Class A (UL) | HumiGuard Plus | 0.90 |
| 3153 SAMPLE | Square Lay-In 15/16 IN | 24 x 48 x 1 IN | White | 0.95 | NA / 190 | Class A (UL) | HumiGuard Plus | 0.90 |
| 3155 SAMPLE | Square Lay-In 15/16 IN | 24 x 48 x 1 1/2 IN | White | 1.00 | NA / 200 | Class A (UL) | HumiGuard Plus | 0.90 |

Cooper Luxicon

| | | Ceiling Uniformity | | | Work Plane Illuminance (Avg. fc) | | |
|----------------|-------------------|--------------------|------|--------------------|----------------------------------|------|----------------------|
| | | 75 | 90 | % lower uniformity | 75 | 90 | % higher illuminance |
| 10x10 Room | 10 | 4 | 4 | 0.00 | 25.7 | 30.8 | 19.84 |
| | 9.75 | 5 | 5 | 0.00 | 27 | 32.6 | 20.74 |
| | 9.5 | 6 | 6 | 0.00 | 28.9 | 34 | 17.65 |
| | 9.25 | 11 | 10 | 10.00 | 31.1 | 37.8 | 21.54 |
| | 9 | 23 | 22 | 4.55 | 32.7 | 39.9 | 22.02 |
| | Avg. | | | 2.91 | | | 20.36 |
| 100x30 Room | 10 | 4 | 3.9 | 2.56 | 52.7 | 64.4 | 22.90 |
| | 9.75 | 5.9 | 5.5 | 7.27 | 52.1 | 65.9 | 24.11 |
| | 9.5 | 9.7 | 8.9 | 8.99 | 53.8 | 66.4 | 23.42 |
| | 9.25 | 17.8 | 15.6 | 14.10 | 53.6 | 55.4 | 23.88 |
| | 9 | 34.8 | 29.7 | 17.17 | 54.3 | 67.3 | 23.94 |
| | Avg. | | | 10.02 | | | 23.65 |
| 60x60 Room | 10 | 5.1 | 4.9 | 4.08 | 54.8 | 67.5 | 23.18 |
| | 9.75 | 7.9 | 7 | 12.86 | 55.7 | 68.8 | 23.52 |
| | 9.5 | 12.7 | 11.5 | 10.43 | 56.6 | 69.9 | 23.50 |
| | 9.25 | 23 | 20 | 15.00 | 57.8 | 71.7 | 24.05 |
| | 9 | 42.4 | 35.5 | 19.44 | 55.1 | 68.1 | 23.59 |
| | Avg. | | | 12.36 | | | 23.57 |
| Irregular Room | 10 | 4.3 | 4.2 | 2.38 | 62 | 76.3 | 23.06 |
| | 9.75 | 6 | 5.8 | 3.45 | 63 | 77.1 | 22.38 |
| | 9.5 | 9.2 | 8.2 | 12.20 | 64.1 | 78.8 | 22.93 |
| | 9.25 | 15.1 | 13.4 | 12.69 | 65.5 | 80.5 | 22.90 |
| | 9 | 30 | 25.2 | 19.05 | 66.6 | 82.4 | 23.72 |
| | Avg. | | | 9.95 | | | 23.00 |
| | Total Avg. | | | 8.81 | | | 22.64 |

Average within IESNA 10:1 5.32

Average Excluding Single Office 6.72

within IESNA 10:1

AGI 32

| | | Ceiling Uniformity | | | Work Plane Illuminance (Avg. fc) | | |
|----------------|-------------------|--------------------|-------|--------------------|----------------------------------|-------|----------------------|
| | | 75 | 90 | % lower uniformity | 75 | 90 | % higher illuminance |
| 10x10 Room | 10 | 2.45 | 2.41 | 1.66 | 19.3 | 23.4 | 21.24 |
| | 9.75 | 2.75 | 2.71 | 1.48 | 20.37 | 24.75 | 21.50 |
| | 9.5 | 3.18 | 3.12 | 1.92 | 21.23 | 26.01 | 22.52 |
| | 9.25 | 4.21 | 4.12 | 2.18 | 21.94 | 26.84 | 22.33 |
| | 9 | 7.7 | 7.44 | 3.49 | 21.52 | 26.33 | 22.35 |
| | Avg. | | | 2.15 | | | 21.99 |
| 100x30 Room | 10 | 4.71 | 4.34 | 8.53 | 41.7 | 51.73 | 24.05 |
| | 9.75 | 6.28 | 6.03 | 4.15 | 41.69 | 51.44 | 23.39 |
| | 9.5 | 9.17 | 8.63 | 6.26 | 41.6 | 50.97 | 22.52 |
| | 9.25 | 15.63 | 13.6 | 14.93 | 40.95 | 50.31 | 22.86 |
| | 9 | 27.79 | 23.85 | 16.52 | 39.55 | 48.59 | 22.86 |
| | Avg. | | | 10.07 | | | 23.14 |
| 60x60 Room | 10 | 4.73 | 4.48 | 5.58 | 42.52 | 52.22 | 22.81 |
| | 9.75 | 6.26 | 5.84 | 7.19 | 42.57 | 52.3 | 22.86 |
| | 9.5 | 9.41 | 8.1 | 16.17 | 42.12 | 52.11 | 23.72 |
| | 9.25 | 13.72 | 11.6 | 18.28 | 41.78 | 51.77 | 23.91 |
| | 9 | 22.8 | 16.84 | 32.39 | 40.11 | 50.21 | 25.18 |
| | Avg. | | | 16.52 | | | 23.70 |
| Irregular Room | 10 | 3.61 | 3.26 | 10.74 | 52.3 | 64.03 | 22.43 |
| | 9.75 | 4.96 | 4.37 | 13.50 | 52.49 | 63.94 | 21.81 |
| | 9.5 | 7.82 | 6.31 | 23.93 | 52.59 | 63.77 | 21.26 |
| | 9.25 | 12.85 | 9.9 | 29.80 | 52.56 | 62.91 | 19.69 |
| | 9 | 23.68 | 15.86 | 49.31 | 52.54 | 61.13 | 16.35 |
| | Avg. | | | 25.45 | | | 20.31 |
| | Total Avg. | | | 13.55 | | | 22.28 |

| | |
|---------------------------|------|
| Average within IESNA 10:1 | 9.11 |
|---------------------------|------|

| | |
|---|-------|
| Average Excluding Single Office within IESNA 10:1 | 12.58 |
|---|-------|

A7

LITEPRO

| | | Ceiling Uniformity | | | Work Plane Illuminance (Avg. fc) | | |
|----------------|-------------------|--------------------|-------|--------------------|----------------------------------|------|----------------------|
| | | 75 | 90 | % lower uniformity | 75 | 90 | % higher illuminance |
| 10x10 Room | 10 | 4.12 | 3.99 | 3.18 | 24.7 | 29.9 | 21.01 |
| | 9.75 | 5.16 | 4.97 | 3.83 | 26.7 | 32.4 | 21.35 |
| | 9.5 | 7.25 | 6.89 | 5.19 | 28.6 | 34.8 | 21.68 |
| | 9.25 | 12.22 | 11.44 | 6.75 | 30.3 | 37 | 22.11 |
| | 9 | 25.45 | 22.96 | 10.86 | 30.7 | 37.6 | 22.48 |
| | Avg. | | | 5.96 | | | 21.73 |
| 100x30 Room | 10 | 4.05 | 3.89 | 4.11 | 54.9 | 67.8 | 23.50 |
| | 9.75 | 5.91 | 5.57 | 6.16 | 55.4 | 68.5 | 23.65 |
| | 9.5 | 9.74 | 8.82 | 9.16 | 56.8 | 70.2 | 23.59 |
| | 9.25 | 17.45 | 15.32 | 13.90 | 57.6 | 71.2 | 23.61 |
| | 9 | 32.90 | 27.61 | 19.18 | 58.2 | 72.1 | 23.88 |
| | Avg. | | | 10.50 | | | 23.65 |
| 60x60 Room | 10 | 5.18 | 4.88 | 6.15 | 52.5 | 65 | 23.81 |
| | 9.75 | 7.80 | 7.20 | 8.33 | 53 | 65.7 | 23.96 |
| | 9.5 | 12.40 | 11.05 | 12.22 | 53.7 | 66.5 | 23.84 |
| | 9.25 | 20.64 | 17.76 | 16.22 | 54.7 | 67.7 | 23.77 |
| | 9 | 37.30 | 30.70 | 21.50 | 55.2 | 68.4 | 23.91 |
| | Avg. | | | 12.88 | | | 23.86 |
| Irregular Room | 10 | 3.94 | 3.75 | 5.12 | 62.7 | 77.6 | 23.76 |
| | 9.75 | 5.65 | 5.29 | 6.78 | 63.2 | 78.3 | 23.89 |
| | 9.5 | 9.18 | 8.40 | 9.18 | 63.6 | 78.8 | 23.90 |
| | 9.25 | 16.09 | 14.21 | 13.21 | 64.3 | 79.6 | 23.79 |
| | 9 | 29.76 | 25.45 | 16.97 | 64.6 | 80.1 | 23.99 |
| | Avg. | | | 10.25 | | | 23.87 |
| | Total Avg. | | | 9.90 | | | 23.28 |

| | |
|---|------|
| Average within IESNA 10:1 | 6.11 |
| Average Excluding Single Office within IESNA 10:1 | 6.88 |

ENERGY ANALYSIS

| | | Indirect Lighting 75% Ceiling | Indirect Lighting 90% Ceiling | 2x2 Parabolic 75% Ceiling |
|----------------------------------|------------------------|----------------------------------|----------------------------------|------------------------------|
| 100x30x10 | Ceiling Uniformity | 5 | 6.80 | |
| | Work Plane Illuminance | 55 | 54.50 | 53.6 |
| | Power Density | 1.20 | 0.96 | 1.12 |
| % Improvement by using Layout 3: | | 20.00% | | 14.29% |

| | | | | |
|----------------------------------|------------------------|--------|-------|--------|
| 60x60x10 | Ceiling Uniformity | 6 | 7.40 | |
| | Work Plane Illuminance | 52.9 | 54.40 | 54.3 |
| | Power Density | 1.17 | 1.00 | 1.46 |
| % Improvement by using Layout 3: | | 14.29% | | 31.43% |

| | | | | |
|----------------------------------|------------------------|---------------|-------|---------------|
| Irregular | Ceiling Uniformity | 4.6 | 8.00 | |
| | Work Plane Illuminance | 55 | 50.00 | 53.5 |
| | Power Density | 1.40 | 0.90 | 1.09 |
| % Improvement by using Layout 3: | | 35.71% | | 17.71% |
| Avg. | | 23.33% | | 21.14% |

POWER DENSITY CALCULATIONS

| Room | Area (ft ²) | No. of Fixtures | W/Fixture | W/ft ² |
|--|-------------------------|-----------------|-----------|-------------------|
| Comparison of 75% and 90% reflective ceiling | | | | |
| 10x10 | 100 | 2 | 60 | 1.20 |
| 100x30 | 3000 | 60 | 60 | 1.20 |
| 60x60 | 3600 | 70 | 60 | 1.17 |
| Irregular | 4800 | 112 | 60 | 1.40 |

| Energy Analysis | | | | |
|---|------|----|----|------|
| Layout 2: Standard Layout with 75% Reflective Ceiling | | | | |
| 100x30 | 3000 | 60 | 60 | 1.20 |
| 60x60 | 3600 | 70 | 60 | 1.20 |
| Irregular | 4800 | 96 | 60 | 1.20 |
| Layout 3: Improved Layout with 90% Reflective Ceiling | | | | |
| 100x30 | 3000 | 48 | 60 | 0.96 |
| 60x60 | 3600 | 60 | 60 | 1.00 |
| Irregular | 4800 | 72 | 60 | 0.90 |
| Layout 4: 2x2 Parabolic Troffers | | | | |
| 100x30 | 3000 | 48 | 70 | 1.12 |
| 60x60 | 3600 | 75 | 70 | 1.46 |
| Irregular | 4800 | 75 | 70 | 1.09 |

A10

100'x30'x10' Open Office, 10' Luminaire Spacing

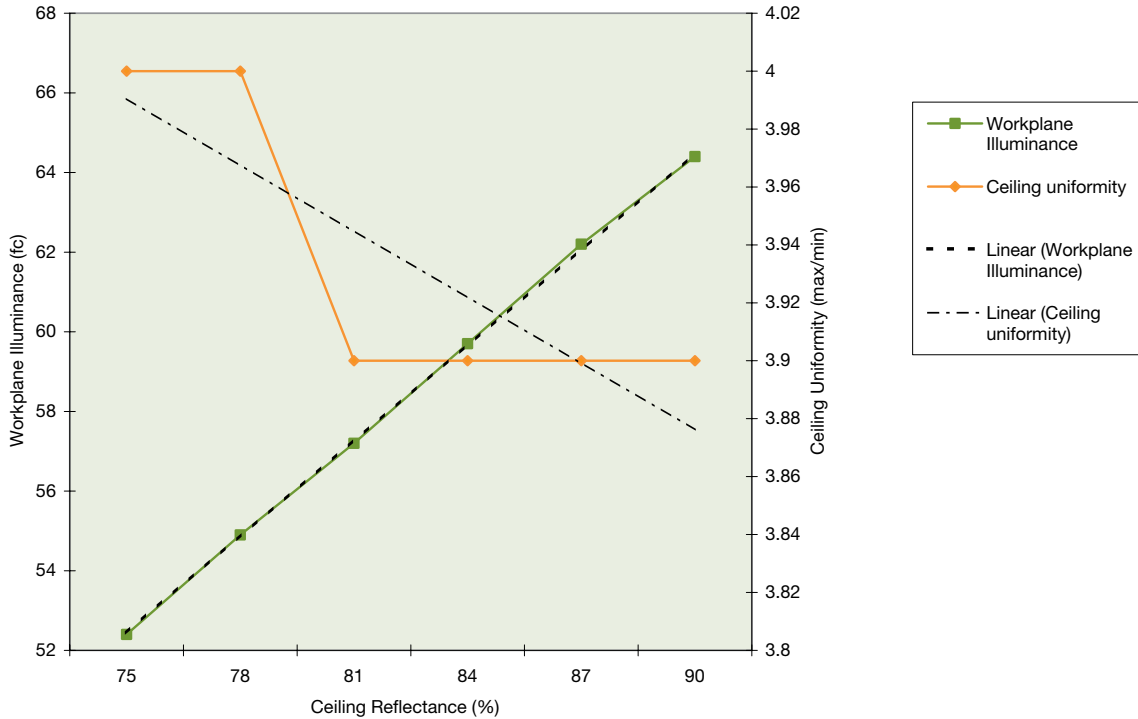

60'x60'x10' Open Office, 12' Luminaire Spacing

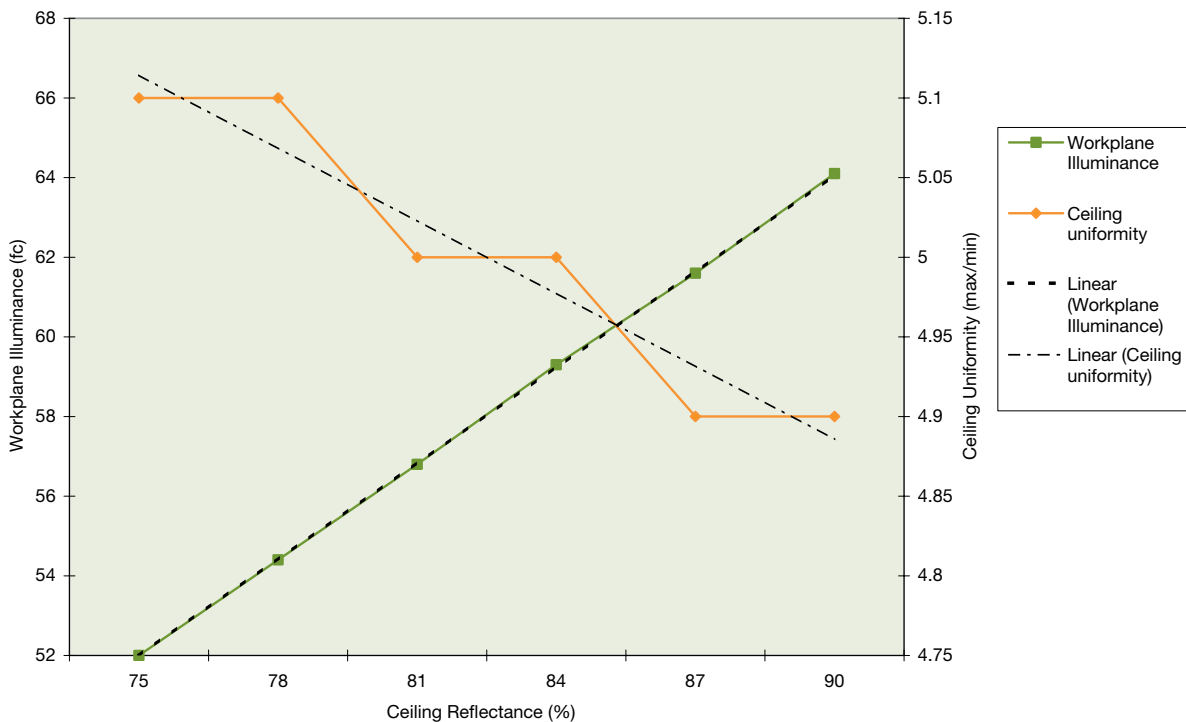

A10

60'x60'x9.5', 12' Luminaire Spacing

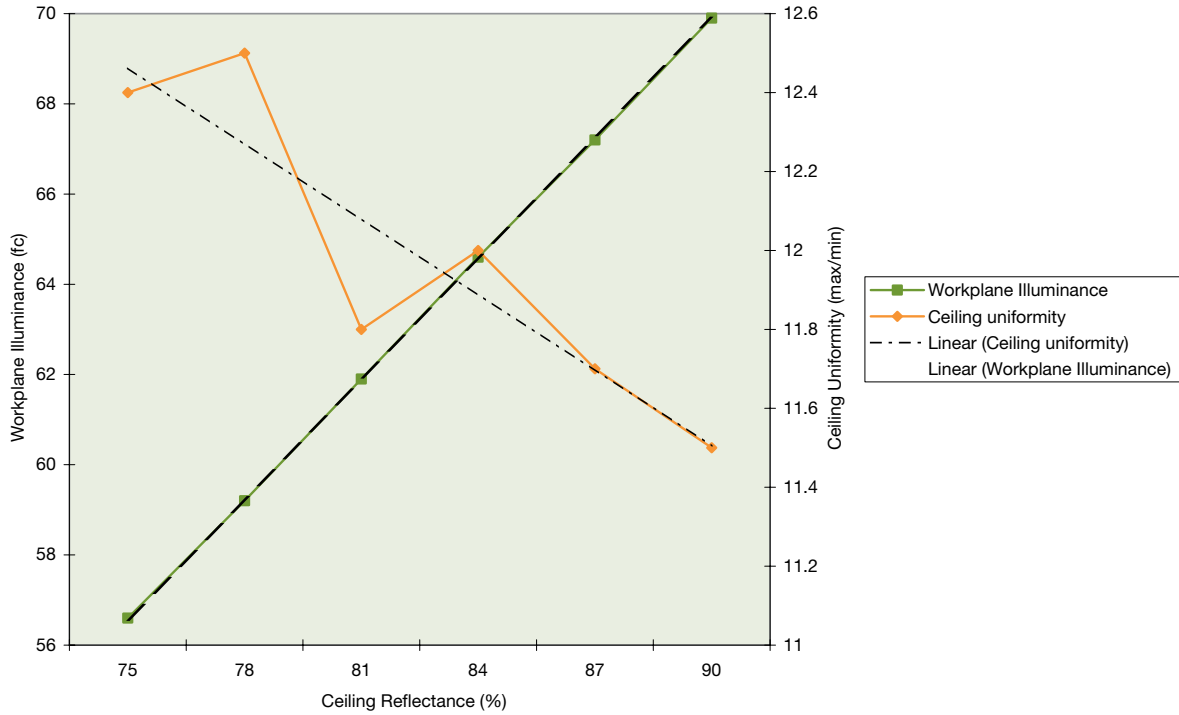

Irregular Open Office, 10' Ceiling Height, 12' Luminaire Spacing

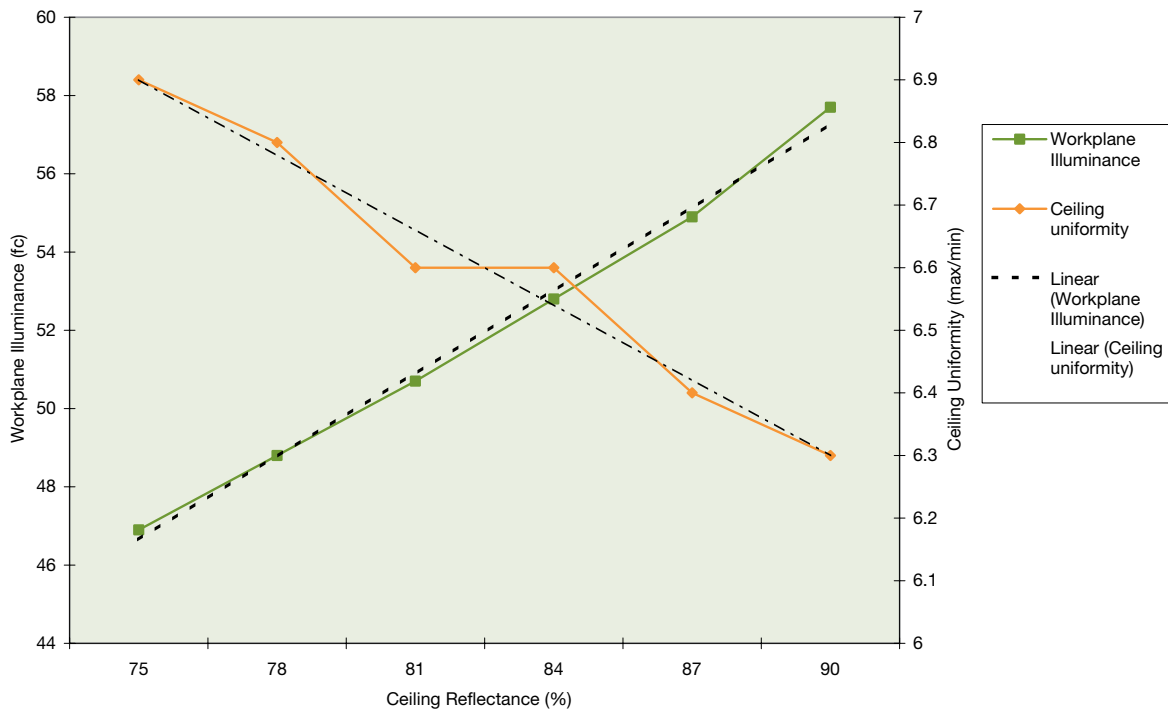

High Reflectance Ceiling Tile Study

Building Energy Analysis

Savings comparison with the HLRC system compared to the respective system

| Lighting savings with 90% Ceiling \$. | HVAC savings with 90% Ceiling \$. | Total savings with 90% Ceiling \$. | Percent of Lighting Savings % | Percent of HVAC Savings % | Percent of Total Savings % |
|---------------------------------------|-----------------------------------|------------------------------------|-------------------------------|---------------------------|----------------------------|
| 548 | 100 | 648 | 19.2 | 5.9 | 14.3 |
| 461 | 84 | 545 | 13.9 | 4.5 | 10.5 |
| 1,791 | 388 | 2,179 | 34.7 | 15.4 | 28.4 |
| 2,531 | 499 | 3,030 | 24.2 | 9.1 | 19.0 |

| Lighting savings with 90% Ceiling \$. | HVAC savings with 90% Ceiling \$. | Total savings with 90% Ceiling \$. | Percent of Lighting Savings % | Percent of HVAC Savings % | Percent of Total Savings % |
|---------------------------------------|-----------------------------------|------------------------------------|-------------------------------|---------------------------|----------------------------|
| 547 | 98 | 645 | 19.1 | 4.8 | 13.1 |
| 461 | 82 | 543 | 13.9 | 3.9 | 10.0 |
| 1,793 | 378 | 2,171 | 34.7 | 14.2 | 27.7 |
| 2,535 | 481 | 3,016 | 24.2 | 7.8 | 18.2 |

Model Results - Trane Tracer

| Northem Exposure | Area (SF) | Lighting Power Density | Annual Lighting Cost \$ | Maximum Cooling Load (Ton) | Max Block CFM | Annual Cooling Cost \$ | Annual Heating Cost \$ | Annual Fan Cost \$ | Total HVAC Cost \$ | Total Annual Cost \$ |
|-------------------------------|--------------|------------------------|-------------------------|----------------------------|---------------|------------------------|------------------------|--------------------|--------------------|----------------------|
| 75% Reflective Ceiling | | | | | | | | | | |
| 100 x 30 | 3000 | 1.2 | 2,853 | 6.4 | 2,025 | 1,092 | 0 | 590 | 1,682 | 4,535 |
| 60 x 60 | 3600 | 1.17 | 3,305 | 6.9 | 2,046 | 1,196 | 0 | 667 | 1,863 | 5,168 |
| Irregular | 4800 | 1.4 | 5,157 | 9.0 | 2,646 | 1,603 | 0 | 918 | 2,521 | 7,678 |
| Total | 11400 | 1.27 | 10,458 | 22.3 | 6,717 | 3,444 | 0 | 2,055 | 5,499 | 15,957 |
| 90% Reflective Ceiling | | | | | | | | | | |
| 100 x 30 | 3000 | 0.96 | 2,305 | 6.1 | 1,881 | 1,039 | 1 | 542 | 1,582 | 3,887 |
| 60 x 60 | 3600 | 1 | 2,844 | 6.6 | 1,931 | 1,154 | 0 | 625 | 1,779 | 4,623 |
| Irregular | 4800 | 0.9 | 3,366 | 8.0 | 2,197 | 1,396 | 0 | 747 | 2,133 | 5,499 |
| Total | 11400 | 0.947 | 7,927 | 20.7 | 6,018 | 3,187 | 1 | 1,812 | 5,000 | 12,927 |
| 2x2 Troffer Ceiling | | | | | | | | | | |
| 100 x 30 | 3000 | 1.12 | 2,671 | 6.3 | 1,981 | 1,079 | 0 | 574 | 1,653 | 4,324 |
| 60 x 60 | 3600 | 1.46 | 4,088 | 7.3 | 2,241 | 1,313 | 0 | 741 | 2,054 | 6,142 |
| Irregular | 4800 | 1.09 | 4,050 | 8.4 | 2,367 | 1,468 | 0 | 812 | 2,280 | 6,330 |
| Total | 11400 | 1.21 | 10,003 | 22.0 | 6,589 | 3,407 | 0 | 1,995 | 5,402 | 15,405 |

| Southern Exposure | Area (SF) | Lighting Power Density | Annual Lighting Cost \$ | Maximum Cooling Load (Ton) | Max Block CFM | Annual Cooling Cost \$ | Annual Heating Cost \$ | Annual Fan Cost \$ | Total HVAC Cost \$ | Total Annual Cost \$ |
|-------------------------------|--------------|------------------------|-------------------------|----------------------------|---------------|------------------------|------------------------|--------------------|--------------------|----------------------|
| 75% Reflective Ceiling | | | | | | | | | | |
| 100 x 30 | 3000 | 1.2 | 2,868 | 7.60 | 2,896 | 1,252 | 0 | 792 | 2,044 | 4,912 |
| 60 x 60 | 3600 | 1.17 | 3,316 | 7.60 | 2,566 | 1,318 | 0 | 810 | 2,128 | 5,444 |
| Irregular | 4800 | 1.4 | 5,169 | 9.50 | 2,910 | 1,668 | 0 | 998 | 2,666 | 7,835 |
| Total | 11400 | 1.27 | 10,481 | 24.30 | 8,381 | 3,709 | 0 | 2,423 | 6,132 | 16,613 |
| 90% Reflective Ceiling | | | | | | | | | | |
| 100 x 30 | 3000 | 0.96 | 2,321 | 7.40 | 2,763 | 1,204 | 0 | 742 | 1,946 | 4,267 |
| 60 x 60 | 3600 | 1 | 2,855 | 7.40 | 2,442 | 1,278 | 0 | 768 | 2,046 | 4,901 |
| Irregular | 4800 | 0.9 | 3,376 | 8.40 | 2,464 | 1,459 | 0 | 829 | 2,298 | 5,664 |
| Total | 11400 | 0.947 | 7,946 | 22.70 | 7,669 | 3,486 | 0 | 1,185 | 5,651 | 13,597 |
| 2x2 Troffer Ceiling | | | | | | | | | | |
| 100 x 30 | 3000 | 1.12 | 2,687 | 7.50 | 2,852 | 1,241 | 0 | 775 | 2,016 | 4,703 |
| 60 x 60 | 3600 | 1.46 | 4,101 | 8.10 | 2,749 | 1,434 | 0 | 885 | 2,319 | 6,420 |
| Irregular | 4800 | 1.09 | 4,061 | 8.80 | 2,633 | 1,539 | 0 | 892 | 2,431 | 6,492 |
| Total | 11400 | 1.21 | 10,024 | 24.00 | 8,234 | 3,680 | 0 | 2,369 | 6,049 | 16,073 |

Note 1) The individual room calculations were conducted as if the space was the complete building and applied the energy rates accordingly.

Note 2) The totals for each ceiling type assume all three spaces are added together as part of a larger building and apply the energy rates accordingly.

Note 3) The difference in lighting costs between the northern and southern exposures are related to the overall change in energy rates due to the increased amount of energy used by the HVAC system.

High Reflectance Ceiling Tile Study

LEED NC Version 2.1 Analysis

Savings for LEED 2.1

| Lighting savings \$ | HVAC savings \$ | Total savings \$ | Percent of Lighting Savings % | Percent of HVAC Savings % | Percent of Total Savings % |
|---------------------|-----------------|------------------|-------------------------------|---------------------------|----------------------------|
| 189 | 42 | 231 | 6.2 | 2.4 | 4.8 |
| 345 | 64 | 410 | 9.5 | 3.3 | 7.3 |
| -291 | -78 | -367 | -6.0 | -3.2 | -5.0 |
| 1,102 | 46 | 1,148 | 9.5 | 0.8 | 6.7 |
| | | | | | |
| 737 | 142 | 879 | 24.2 | 8.2 | 18.4 |
| 8.6 | 148 | 955 | 22.1 | 7.7 | 17.1 |
| 1,501 | 310 | 1,812 | 30.8 | 12.7 | 24.8 |
| 3,633 | 545 | 4,178 | 31.4 | 9.8 | 24.4 |
| | | | | | |
| 371 | 71 | 442 | 12.2 | 4.1 | 9.3 |
| 438 | 127 | 564 | -12.0 | -6.6 | -10.1 |
| 817 | 163 | 981 | 16.8 | 6.7 | 13.4 |
| 1,557 | 143 | 1,700 | 13.5 | 2.6 | 9.9 |

| Lighting savings \$ | HVAC savings \$ | Total savings \$ | Percent of Lighting Savings % | Percent of HVAC Savings % | Percent of Total Savings % |
|---------------------|-----------------|------------------|-------------------------------|---------------------------|----------------------------|
| 174 | 41 | 215 | 5.7 | 2.0 | 4.2 |
| 334 | 63 | 397 | 9.2 | 2.9 | 6.8 |
| -302 | -76 | -377 | -6.2 | -2.9 | -5.1 |
| 1,079 | 45 | 1,123 | 9.3 | 0.7 | 6.3 |
| | | | | | |
| 721 | 139 | 860 | 23.7 | 6.7 | 16.8 |
| 795 | 145 | 940 | 21.8 | 6.6 | 16.1 |
| 1,491 | 302 | 1,794 | 30.6 | 11.7 | 24.1 |
| 3,614 | 526 | 4,139 | 31.3 | 8.5 | 23.3 |
| | | | | | |
| 355 | 69 | 424 | 11.7 | 3.3 | 8.3 |
| -451 | -128 | -579 | -12.3 | -5.9 | -9.9 |
| 806 | 159 | 966 | 16.6 | 6.2 | 12.9 |
| 1,536 | 128 | 1,663 | 13.3 | 2.1 | 9.4 |

Model Results - Trane Tracer

| Nothorn Exposure | Area (SF) | Lighting Power Density | Annual Lighting Cost \$ | Maximum Cooling Load (Ton) | Max Block CFM | Annual Cooling Cost \$ | Annual Heating Cost \$ | Annual Fan Cost \$ | Total HVAC Cost \$ | Total Annual Cost \$ |
|-------------------------------|--------------|------------------------|-------------------------|----------------------------|----------------|------------------------|------------------------|--------------------|--------------------|----------------------|
| 75% Reflective Ceiling | | | | | | | | | | |
| 100 x 30 | 3000 | 1.2 | 2,853 | 6.4 | 2,025 | 1,092 | 0 | 590 | 1,682 | 4,535 |
| 60 x 60 | 3600 | 1.17 | 3,305 | 6.9 | 2,046 | 1,196 | 0 | 667 | 1,863 | 5,168 |
| Irregular | 4800 | 1.4 | 5,157 | 9.0 | 2,646 | 1,603 | 0 | 918 | 2,521 | 7,678 |
| Total | 11400 | 1.27 | 10,458 | 22.3 | 6,717 | 3,444 | 0 | 2,055 | 5,499 | 15,957 |
| 90% Reflective Ceiling | | | | | | | | | | |
| 100 x 30 | 3000 | 0.96 | 2,305 | 6.1 | 1,881 | 1,039 | 1 | 542 | 1,582 | 3,887 |
| 60 x 60 | 3600 | 1 | 2,844 | 6.6 | 1,931 | 1,154 | 0 | 625 | 1,779 | 4,623 |
| Irregular | 4800 | 0.9 | 3,366 | 8.0 | 2,197 | 1,386 | 0 | 747 | 2,133 | 5,499 |
| Total | 11400 | 0.947 | 7,927 | 20.7 | 6,018 | 3,187 | 1 | 1,812 | 5,000 | 12,927 |
| 2x2 Troffer Ceiling | | | | | | | | | | |
| 100 x 30 | 3000 | 1.12 | 2,671 | 6.3 | 1,981 | 1,079 | 0 | 574 | 1,653 | 4,324 |
| 60 x 60 | 3600 | 1.46 | 4,088 | 7.3 | 2,241 | 1,313 | 0 | 741 | 2,054 | 6,142 |
| Irregular | 4800 | 1.09 | 4,050 | 8.4 | 2,367 | 1,488 | 0 | 812 | 2,280 | 6,330 |
| Total | 11400 | 1.21 | 10,003 | 22.0 | 6,589 | 3,407 | 0 | 1,995 | 5,402 | 15,405 |
| ASHRAE 90.1 1999 | | | | | | | | | | |
| 100 x 30 | 3000 | 1.3 | 3,042 | 6.5 | 2,080.8 | 1,114.1 | 0 | 610.0 | 1,724 | 4,766 |
| 60 x 60 | 3600 | 1.3 | 3,650 | 7.1 | 2,133.9 | 1,228.1 | 0 | 699.1 | 1,927 | 5,578 |
| Irregular | 4800 | 1.3 | 4,867 | 8.8 | 2,556.2 | 1,559.6 | 0 | 883.8 | 2,443 | 7,311 |
| Total | 11400 | 1.3 | 11,560 | 22.4 | 6,781.9 | 3,467.9 | 0 | 2,077.6 | 5,545 | 17,105 |

| Southern Exposure | Area (SF) | Lighting Power Density | Annual Lighting Cost \$ | Maximum Cooling Load (Ton) | Max Block CFM | Annual Cooling Cost \$ | Annual Heating Cost \$ | Annual Fan Cost \$ | Total HVAC Cost \$ | Total Annual Cost \$ |
|-------------------------------|--------------|------------------------|-------------------------|----------------------------|----------------|------------------------|------------------------|--------------------|--------------------|----------------------|
| 75% Reflective Ceiling | | | | | | | | | | |
| 100 x 30 | 3000 | 1.2 | 2,868 | 7.60 | 2,896 | 1,252 | 0 | 792 | 2,044 | 4,912 |
| 60 x 60 | 3600 | 1.17 | 3,316 | 7.60 | 2,566 | 1,318 | 0 | 810 | 2,128 | 5,444 |
| Irregular | 4800 | 1.4 | 5,169 | 9.50 | 2,910 | 1,668 | 0 | 998 | 2,666 | 7,835 |
| Total | 11400 | 1.27 | 10,481 | 24.30 | 8,381 | 3,709 | 0 | 2,423 | 6,132 | 16,613 |
| 90% Reflective Ceiling | | | | | | | | | | |
| 100 x 30 | 3000 | 0.96 | 2,321 | 7.40 | 2,763 | 1,204 | 0 | 742 | 1,946 | 4,267 |
| 60 x 60 | 3600 | 1 | 2,855 | 7.40 | 2,442 | 1,278 | 0 | 768 | 2,046 | 4,901 |
| Irregular | 4800 | 0.9 | 3,376 | 8.40 | 2,464 | 1,459 | 0 | 829 | 2,268 | 5,664 |
| Total | 11400 | 0.947 | 7,946 | 22.70 | 7,669 | 3,486 | 0 | 1,185 | 5,651 | 13,597 |
| 2x2 Troffer Ceiling | | | | | | | | | | |
| 100 x 30 | 3000 | 1.12 | 2,687 | 7.50 | 2,852 | 1,241 | 0 | 775 | 2,016 | 4,703 |
| 60 x 60 | 3600 | 1.46 | 4,101 | 8.10 | 2,749 | 1,434 | 0 | 885 | 2,319 | 6,420 |
| Irregular | 4800 | 1.09 | 4,061 | 8.80 | 2,633 | 1,539 | 0 | 892 | 2,431 | 6,492 |
| Total | 11400 | 1.21 | 10,024 | 24.00 | 8,234 | 3,660 | 0 | 2,369 | 6,049 | 16,073 |
| ASHRAE 90.1 1999 | | | | | | | | | | |
| 100 x 30 | 3000 | 1.3 | 3,042 | 7.7 | 2,851.4 | 1,272.0 | 0 | 812.8 | 2,085 | 5,127 |
| 60 x 60 | 3600 | 1.3 | 3,650 | 7.8 | 2,643.2 | 1,348.6 | 0 | 842.1 | 2,191 | 5,841 |
| Irregular | 4800 | 1.3 | 4,867 | 9.3 | 2,820.8 | 1,626.2 | 0 | 964.2 | 2,580 | 7,458 |
| Total | 11400 | 1.3 | 11,560 | 24.4 | 8,425.3 | 3,731.6 | 0 | 2,445.1 | 6,177 | 17,736 |

High Reflectance Ceiling Tile Study

LEED NC Version 2.2 Analysis

Savings for LEED 2.2

| Lighting savings \$ | HVAC savings \$ | Total savings \$ | Percent of Lighting Savings % | Percent of HVAC Savings % | Percent of Total Savings % |
|---------------------|-----------------|------------------|-------------------------------|---------------------------|----------------------------|
| -279 | -42 | -321 | -10.8 | -2.6 | -7.6 |
| -216 | -35 | -251 | -7.0 | -1.9 | -5.1 |
| -1,039 | -233 | -1,271 | -25.2 | -10.2 | -19.8 |
| -677 | -263 | -940 | -6.9 | -5.0 | -6.3 |
| 269 | 58 | 327 | 10.5 | 3.5 | 7.8 |
| 245 | 49 | 294 | 7.9 | 2.7 | 6.0 |
| 752 | 155 | 908 | 18.3 | 6.8 | 14.2 |
| 1,8854 | 236 | 2,090 | 19.0 | 4.5 | 13.9 |
| -97 | -13 | -110 | -3.8 | -0.8 | -2.6 |
| -989 | -226 | -1,225 | -32.3 | -12.3 | -24.9 |
| 69 | 8 | 77 | 1.7 | 0.4 | 1.2 |
| -222 | -166 | -388 | -2.3 | -3.2 | -2.6 |

| Lighting savings \$ | HVAC savings \$ | Total savings \$ | Percent of Lighting Savings % | Percent of HVAC Savings % | Percent of Total Savings % |
|---------------------|-----------------|------------------|-------------------------------|---------------------------|----------------------------|
| -294 | -41 | -335 | -11.4 | -2.0 | -7.3 |
| -227 | -34 | -261 | -7.4 | -1.6 | -5.0 |
| -1,051 | -227 | -1,277 | -25.5 | -9.3 | -19.5 |
| -700 | -253 | -953 | -7.2 | -4.3 | -6.1 |
| 263 | 57 | 310 | 9.8 | 2.9 | 6.8 |
| 234 | 48 | 282 | 7.6 | 2.3 | 5.4 |
| 742 | 151 | 894 | 18.0 | 6.2 | 13.6 |
| 1,835 | 228 | 2,063 | 18.8 | 3.9 | 13.2 |
| -113 | -13 | -126 | -4.4 | -0.6 | -2.7 |
| -1,012 | -225 | -1,237 | -32.8 | -10.7 | -23.9 |
| 57 | 8 | 66 | 1.4 | 0.3 | 1.0 |
| -242 | -170 | -413 | -2.5 | -2.9 | -2.6 |

Model Results - Trane Tracer

| Northem Exposure | Area (SF) | Lighting Power Density | Annual Lighting Cost \$ | Maximum Cooling Load (Ton) | Max Block CFM | Annual Cooling Cost \$ | Annual Heating Cost \$ | Annual Fan Cost \$ | Total HVAC Cost \$ | Total Annual Cost \$ |
|-------------------------------|--------------|------------------------|-------------------------|----------------------------|---------------|------------------------|------------------------|--------------------|--------------------|----------------------|
| 75% Reflective Ceiling | | | | | | | | | | |
| 100 x 30 | 3000 | 1.2 | 2,853 | 6.4 | 2,025 | 1,092 | 0 | 590 | 1,682 | 4,535 |
| 60 x 60 | 3600 | 1.17 | 3,305 | 6.9 | 2,046 | 1,196 | 0 | 667 | 1,863 | 5,168 |
| Irregular | 4800 | 1.4 | 5,157 | 9.0 | 2,646 | 1,603 | 0 | 918 | 2,521 | 7,678 |
| Total | 11400 | 1.27 | 10,458 | 22.3 | 6,717 | 3,444 | 0 | 2,055 | 5,499 | 15,957 |
| 90% Reflective Ceiling | | | | | | | | | | |
| 100 x 30 | 3000 | 0.96 | 2,305 | 6.1 | 1,881 | 1,039 | 1 | 542 | 1,582 | 3,887 |
| 60 x 60 | 3600 | 1 | 2,844 | 6.6 | 1,931 | 1,154 | 0 | 625 | 1,779 | 4,623 |
| Irregular | 4800 | 0.9 | 3,366 | 8.0 | 2,197 | 1,386 | 0 | 747 | 2,133 | 5,499 |
| Total | 11400 | 0.947 | 7,927 | 20.7 | 6,018 | 3,187 | 1 | 1,812 | 5,000 | 12,927 |
| 2x2 Troffer Ceiling | | | | | | | | | | |
| 100 x 30 | 3000 | 1.12 | 2,671 | 6.3 | 1,981 | 1,079 | 0 | 574 | 1,653 | 4,324 |
| 60 x 60 | 3600 | 1.46 | 4,088 | 7.3 | 2,241 | 1,313 | 0 | 741 | 2,054 | 6,142 |
| Irregular | 4800 | 1.09 | 4,050 | 8.4 | 2,367 | 1,488 | 0 | 812 | 2,290 | 6,330 |
| Total | 11400 | 1.21 | 10,003 | 22.0 | 6,589 | 3,407 | 0 | 1,995 | 5,402 | 15,405 |
| ASHRAE 90.1 2004 | | | | | | | | | | |
| 100 x 30 | 3000 | 1.1 | 2,574 | 6.3 | 1,969.2 | 1,069.9 | 0 | 570.0 | 1,640 | 4,214 |
| 60 x 60 | 3600 | 1.1 | 3,089 | 6.8 | 1,998.6 | 1,178.7 | 0 | 649.7 | 1,828 | 4,917 |
| Irregular | 4800 | 1.1 | 4,118 | 8.4 | 2,376.6 | 1,472.8 | 0 | 815.4 | 2,288 | 6,407 |
| Total | 11400 | 1.1 | 9,781 | 21.5 | 6349.1 | 3308.7 | 0 | 1927.1 | 5236 | 15,017 |

| Southern Exposure | Area (SF) | Lighting Power Density | Annual Lighting Cost \$ | Maximum Cooling Load (Ton) | Max Block CFM | Annual Cooling Cost \$ | Annual Heating Cost \$ | Annual Fan Cost \$ | Total HVAC Cost \$ | Total Annual Cost \$ |
|-------------------------------|--------------|------------------------|-------------------------|----------------------------|---------------|------------------------|------------------------|--------------------|--------------------|----------------------|
| 75% Reflective Ceiling | | | | | | | | | | |
| 100 x 30 | 3000 | 1.2 | 2,868 | 7.60 | 2,896 | 1,252 | 0 | 792 | 2,044 | 4,912 |
| 60 x 60 | 3600 | 1.17 | 3,316 | 7.60 | 2,566 | 1,318 | 0 | 810 | 2,128 | 5,444 |
| Irregular | 4800 | 1.4 | 5,169 | 9.50 | 2,910 | 1,668 | 0 | 998 | 2,666 | 7,835 |
| Total | 11400 | 1.27 | 10,481 | 24.30 | 8,381 | 3,709 | 0 | 2,423 | 6,132 | 16,613 |
| 90% Reflective Ceiling | | | | | | | | | | |
| 100 x 30 | 3000 | 0.96 | 2,321 | 7.40 | 2,763 | 1,204 | 0 | 742 | 1,946 | 4,267 |
| 60 x 60 | 3600 | 1 | 2,855 | 7.40 | 2,442 | 1,278 | 0 | 768 | 2,046 | 4,901 |
| Irregular | 4800 | 0.9 | 3,376 | 8.40 | 2,464 | 1,459 | 0 | 829 | 2,268 | 5,664 |
| Total | 11400 | 0.947 | 7,946 | 22.70 | 7669 | 3,486 | 0 | 1,185 | 5,651 | 13,597 |
| 2x2 Troffer Ceiling | | | | | | | | | | |
| 100 x 30 | 3000 | 1.12 | 2,687 | 7.50 | 2,852 | 1,241 | 0 | 775 | 2,016 | 4,703 |
| 60 x 60 | 3600 | 1.46 | 4,101 | 8.10 | 2,749 | 1,434 | 0 | 885 | 2,319 | 6,420 |
| Irregular | 4800 | 1.09 | 4,061 | 8.80 | 2,633 | 1,539 | 0 | 892 | 2,431 | 6,492 |
| Total | 11400 | 1.21 | 10,024 | 24.00 | 8,234 | 3,660 | 0 | 2,369 | 6,049 | 16,073 |
| ASHRAE 90.1 2004 | | | | | | | | | | |
| 100 x 30 | 3000 | 1.1 | 2,574 | 7.5 | 2840.6 | 1232.0 | 0 | 771.2 | 2,003 | 4,577 |
| 60 x 60 | 3600 | 1.1 | 3,089 | 7.5 | 2509.1 | 1301.5 | 0 | 792.7 | 2,094 | 5,183 |
| Irregular | 4800 | 1.1 | 4,118 | 8.8 | 2642.4 | 1542.6 | 0 | 896.6 | 2,439 | 6,558 |
| Total | 11400 | 1.1 | 9,781 | 23.5 | 7996.8 | 3581.1 | 0 | 2297.7 | 5,879 | 15,660 |

High Reflectance Ceiling Tile Study

Building Energy Analysis

Savings comparison with the HLRC system compared to the respective system

| Lighting savings with 90% Ceiling | HVAC savings with 90% Ceiling | Total savings with 90% Ceiling | Percent of Lighting Savings % | Percent of HVAC Savings % | Percent of Total Savings % |
|-----------------------------------|-------------------------------|--------------------------------|-------------------------------|---------------------------|----------------------------|
| 4,402 | 880 | 5,292 | 20.0 | 6.8 | 15.1 |
| 3,750 | 753 | 4,503 | 14.5 | 5.2 | 11.1 |
| 14,685 | 3,352 | 18,037 | 35.7 | 16.6 | 29.4 |
| 22,835 | 5,054 | 27,889 | 25.7 | 10.7 | 20.5 |
| 90% Reflective Ceiling | | | | | |
| 2,933 | 627 | 3,560 | 14.3 | 4.9 | 10.7 |
| 10,137 | 2,389 | 12,526 | 31.5 | 14.7 | 25.9 |
| 5,581 | 1,272 | 6,853 | 17.4 | 7.0 | 13.7 |
| 18,647 | 4,063 | 22,710 | 22.0 | 8.8 | 17.4 |

| Northem Exposure | Area (SF) | Lighting Power Density (W/SF) | Annual Lighting Energy Used (KWh) | Total HVAC Energy in (KWh) | Total Annual Energy in (KWh) |
|----------------------------------|--------------|-------------------------------|-----------------------------------|----------------------------|------------------------------|
| 75% Reflective Ceiling | | | | | |
| 100 x 30 | 3000 | 1.2 | 22,021 | 13,069 | 35,090 |
| 60 x 60 | 3600 | 1.17 | 25,771 | 14,617 | 40,388 |
| Irregular | 4800 | 1.4 | 41,110 | 20,178 | 61,288 |
| Total | 11400 | 1.27 | 88,905 | 47,149 | 136,054 |
| 90% Reflective Ceiling | | | | | |
| 100 x 30 | 3000 | 0.96 | 17,620 | 12,179 | 29,799 |
| 60 x 60 | 3600 | 1 | 22,022 | 13,864 | 35,886 |
| Irregular | 4800 | 0.9 | 26,425 | 16,826 | 43,251 |
| Total | 11400 | 0.947 | 66,070 | 42,095 | 108,165 |
| 108,165x2 Troffer Ceiling | | | | | |
| 100 x 30 | 3000 | 1.12 | 20,562 | 12,806 | 33,368 |
| 60 x 60 | 3600 | 1.46 | 32,159 | 16,253 | 48,412 |
| Irregular | 4800 | 1.09 | 32,005 | 18,098 | 50,103 |
| Total | 11400 | 1.21 | 84,718 | 46,158 | 130,876 |

| Lighting savings with 90% Ceiling | HVAC savings with 90% Ceiling | Total savings with 90% Ceiling | Percent of Lighting Savings % | Percent of HVAC Savings % | Percent of Total Savings % |
|-----------------------------------|-------------------------------|--------------------------------|-------------------------------|---------------------------|----------------------------|
| 4,402 | 917 | 5,319 | 20.0 | 5.8 | 14.1 |
| 3,739 | 749 | 4,488 | 14.5 | 4.5 | 10.6 |
| 14,684 | 3,299 | 17,983 | 35.7 | 15.5 | 28.8 |
| 22,832 | 5,016 | 27,848 | 25.7 | 9.6 | 19.7 |
| 90% Reflective Ceiling | | | | | |
| 2,940 | 649 | 3,589 | 14.3 | 4.2 | 10.0 |
| 10,134 | 2,396 | 12,530 | 31.5 | 13.1 | 24.8 |
| 5,581 | 1,257 | 6,838 | 17.4 | 6.5 | 13.3 |
| 18,641 | 4,125 | 22,766 | 22.0 | 8.0 | 16.7 |

| Northem Exposure | Area (SF) | Lighting Power Density (W/SF) | Annual Lighting Energy Used (KWh) | Total HVAC Energy in (KWh) | Total Annual Energy in (KWh) |
|-------------------------------|--------------|-------------------------------|-----------------------------------|----------------------------|------------------------------|
| 75% Reflective Ceiling | | | | | |
| 100 x 30 | 3000 | 1.2 | 22,020 | 15,775 | 37,795 |
| 60 x 60 | 3600 | 1.17 | 25,766 | 16,618 | 42,384 |
| Irregular | 4800 | 1.4 | 41,114 | 21,286 | 62,400 |
| Total | 11400 | 1.27 | 88,900 | 52,417 | 141,326 |
| 90% Reflective Ceiling | | | | | |
| 100 x 30 | 3000 | 0.96 | 17,618 | 14,858 | 32,476 |
| 60 x 60 | 3600 | 1 | 22,026 | 15,869 | 37,895 |
| Irregular | 4800 | 0.9 | 26,430 | 17,987 | 44,417 |
| Total | 11400 | 0.947 | 66,077 | 47,401 | 113,478 |
| 2x2 Troffer Ceiling | | | | | |
| 100 x 30 | 3000 | 1.12 | 20,568 | 15,507 | 36,065 |
| 60 x 60 | 3600 | 1.46 | 32,160 | 18,265 | 50,425 |
| Irregular | 4800 | 1.09 | 32,011 | 19,244 | 51,255 |
| Total | 11400 | 1.21 | 84,718 | 51,526 | 136,244 |

Note 1) The individual room calculations were conducted as if the space was the complete building and applied the energy rates accordingly.
 Note 2) The totals for each ceiling type assume all three spaces are added together as part of a larger building and apply the energy rates accordingly.
 Note 3) The difference in lighting costs between the northern and southern exposures are related to the overall change in energy rates due to the increased amount of energy used by the HVAC system.

High Reflectance Ceiling Tile Study

LEED NC Version 2.1 Analysis

Savings for LEED 2.1

| Lighting savings \$ | HVAC savings \$ | Total savings \$ | Percent of Lighting Savings % | Percent of HVAC Savings % | Percent of Total Savings % |
|-------------------------------|-----------------|------------------|-------------------------------|---------------------------|----------------------------|
| 189 | 371 | 560 | 7.7 | 2.8 | 5.9 |
| 345 | 576 | 921 | 10.0 | 3.8 | 7.9 |
| -290 | -670 | -960 | -7.7 | -3.4 | -6.3 |
| 1,102 | 469 | 1,571 | 2.3 | 1.0 | 1.9 |
| 90% Reflective Ceiling | | | | | |
| 737 | 1,261 | 1,998 | 26.1 | 9.4 | 20.1 |
| 8.6 | 1,329 | 2,135 | 23.1 | 8.7 | 18.1 |
| 1,501 | 2,682 | 4,183 | 30.8 | 13.7 | 25.0 |
| 3,683 | 5,523 | 9,156 | 27.4 | 11.6 | 22.0 |
| 2x2 Troffer Ceiling | | | | | |
| 371 | 634 | 1,005 | 13.8 | 4.7 | 10.6 |
| 438 | -1,060 | -1,498 | -12.3 | -7.0 | -10.4 |
| 817 | 1,410 | 2,227 | 16.2 | 7.2 | 13.1 |
| 1,557 | 1,460 | 3,017 | 6.9 | 3.1 | 5.6 |

| Lighting savings \$ | HVAC savings \$ | Total savings \$ | Percent of Lighting Savings % | Percent of HVAC Savings % | Percent of Total Savings % |
|-------------------------------|-----------------|------------------|-------------------------------|---------------------------|----------------------------|
| 174 | 382 | 556 | 7.7 | 2.4 | 5.5 |
| 334 | 573 | 907 | 10.0 | 3.3 | 7.5 |
| -302 | -660 | -962 | -7.7 | -3.2 | -6.1 |
| 1,079 | 466 | 1,544 | 2.3 | 0.9 | 1.8 |
| 90% Reflective Ceiling | | | | | |
| 721 | 1,299 | 2,020 | 26.1 | 8.0 | 18.8 |
| 795 | 1,322 | 2,117 | 23.1 | 7.7 | 17.3 |
| 1,491 | 2,639 | 4,130 | 30.8 | 12.8 | 24.5 |
| 3,614 | 5,482 | 9,095 | 27.4 | 10.4 | 21.1 |
| 2x2 Troffer Ceiling | | | | | |
| 355 | 660 | 1,005 | 13.8 | 4.0 | 9.9 |
| -451 | -1,074 | -1,525 | -12.3 | -6.2 | -10.1 |
| 806 | 1,382 | 2,188 | 16.2 | 6.7 | 12.8 |
| 1,536 | 1,357 | 2,892 | 6.9 | 2.6 | 5.3 |

Model Results - Trane Tracer

| Notherm Exposure | Area (SF) | Lighting Power Density (W/SP) | Annual Lighting Energy Used (kWh) | Total HVAC Energy in (kWh) | Total Annual Energy in (kWh) |
|-------------------------------|--------------|-------------------------------|-----------------------------------|----------------------------|------------------------------|
| 75% Reflective Ceiling | | | | | |
| 100 x 30 | 3000 | 1.2 | 22,020 | 13,069 | 35,090 |
| 60 x 60 | 3600 | 1.17 | 25,771 | 14,617 | 40,388 |
| Irregular | 4800 | 1.4 | 41,110 | 20,178 | 61,288 |
| Total | 11400 | 1.27 | 88,905 | 47,149 | 136,054 |
| 90% Reflective Ceiling | | | | | |
| 100 x 30 | 3000 | 0.96 | 17,620 | 12,179 | 29,799 |
| 60 x 60 | 3600 | 1 | 22,022 | 13,864 | 35,886 |
| Irregular | 4800 | 0.9 | 26,425 | 16,826 | 43,251 |
| Total | 11400 | 0.947 | 66,070 | 42,095 | 108,165 |
| 2x2 Troffer Ceiling | | | | | |
| 100 x 30 | 3000 | 1.12 | 20,552 | 12,806 | 33,358 |
| 60 x 60 | 3600 | 1.46 | 32,159 | 16,253 | 48,412 |
| Irregular | 4800 | 1.09 | 32,005 | 18,098 | 50,103 |
| Total | 11400 | 1.21 | 84,718 | 46,158 | 130,876 |
| ASHRAE 90.1 1989 | | | | | |
| 100 x 30 | 3000 | 1.3 | 23,855 | 13,440 | 37,295 |
| 60 x 60 | 3600 | 1.3 | 28,639 | 15,193 | 43,831 |
| Irregular | 4800 | 1.3 | 38,173 | 19,508 | 57,680 |
| Total | 11400 | 1.3 | 91,026 | 47,618 | 138,644 |

| Southern Exposure | Area (SF) | Lighting Power Density (W/SP) | Annual Lighting Energy Used (kWh) | Total HVAC Energy in (kWh) | Total Annual Energy in (kWh) |
|-------------------------------|--------------|-------------------------------|-----------------------------------|----------------------------|------------------------------|
| 75% Reflective Ceiling | | | | | |
| 100 x 30 | 3000 | 1.2 | 22,020 | 15,775 | 37,795 |
| 60 x 60 | 3600 | 1.17 | 25,766 | 16,618 | 42,384 |
| Irregular | 4800 | 1.4 | 41,114 | 21,286 | 62,400 |
| Total | 11400 | 1.27 | 88,909 | 52,417 | 141,326 |
| 90% Reflective Ceiling | | | | | |
| 100 x 30 | 3000 | 0.96 | 17,618 | 14,858 | 32,476 |
| 60 x 60 | 3600 | 1 | 22,026 | 15,869 | 37,895 |
| Irregular | 4800 | 0.9 | 26,430 | 17,987 | 44,417 |
| Total | 11400 | 0.947 | 66,077 | 47,401 | 113,478 |
| 2x2 Troffer Ceiling | | | | | |
| 100 x 30 | 3000 | 1.12 | 20,558 | 15,607 | 36,065 |
| 60 x 60 | 3600 | 1.46 | 32,160 | 18,265 | 50,425 |
| Irregular | 4800 | 1.09 | 32,011 | 19,244 | 51,255 |
| Total | 11400 | 1.21 | 84,718 | 51,526 | 136,244 |
| ASHRAE 90.1 1989 | | | | | |
| 100 x 30 | 3000 | 1.3 | 23,854 | 16,157 | 40,011 |
| 60 x 60 | 3600 | 1.3 | 28,625 | 17,191 | 45,816 |
| Irregular | 4800 | 1.3 | 38,177 | 20,626 | 58,804 |
| Total | 11400 | 1.3 | 91,029 | 52,883 | 143,912 |

High Reflectance Ceiling Tile Study

LEED NC Version 2.2 Analysis

Savings for LEED 2.2

| Lighting savings \$ | HVAC savings \$ | Total savings \$ | Percent of Lighting Savings % | Percent of HVAC Savings % | Percent of Total Savings % |
|---|-----------------|------------------|-------------------------------|---------------------------|----------------------------|
| -279 | -371 | -650 | -9.1 | -2.9 | -6.7 |
| -216 | -310 | -526 | -6.4 | -2.2 | -4.8 |
| -1,039 | -2,011 | -3,050 | -27.3 | -11.1 | -21.4 |
| -677 | -2,660 | -3,337 | -15.6 | -6.0 | -12.1 |
| 75% Reflective Ceiling | | | | | |
| 269 | 519 | 788 | 12.7 | 4.1 | 9.4 |
| 245 | 443 | 688 | 9.1 | 3.1 | 6.9 |
| 752 | 1,341 | 2,093 | 18.2 | 7.4 | 14.3 |
| 1,8854 | 2,394 | 4,248 | 14.1 | 5.4 | 10.9 |
| 90% Reflective Ceiling | | | | | |
| -97 | -108 | -205 | -1.8 | -0.8 | -1.4 |
| -999 | -1,946 | -2,945 | -32.7 | -13.6 | -25.6 |
| 69 | 69 | 127 | 0.9 | 0.4 | 0.7 |
| -222 | -1,669 | -1,891 | -10.2 | -3.8 | -7.8 |
| Avg Savings 75% Reflective Ceiling | | | | | |
| | | | -15.6 | -5.6 | -11.8 |
| Avg Savings 90% Reflective Ceiling | | | | | |
| | | | 14.1 | 5.1 | 10.6 |
| Avg Savings 2x2 Troffer Ceiling | | | | | |
| | | | -10.2 | -3.6 | -7.7 |

| Lighting savings \$ | HVAC savings \$ | Total savings \$ | Percent of Lighting Savings % | Percent of HVAC Savings % | Percent of Total Savings % |
|---|-----------------|------------------|-------------------------------|---------------------------|----------------------------|
| -294 | -382 | -676 | -9.1 | -2.5 | -6.3 |
| -227 | -308 | -536 | -6.4 | -1.9 | -4.6 |
| -1,051 | -1,979 | -3,030 | -27.3 | -10.3 | -20.9 |
| -700 | -2,640 | -3,340 | -15.6 | -5.3 | -11.6 |
| 75% Reflective Ceiling | | | | | |
| 253 | 535 | 788 | 12.7 | 3.5 | 8.7 |
| 234 | 441 | 674 | 9.1 | 2.7 | 6.5 |
| 742 | 1,320 | 2,062 | 18.2 | 6.8 | 13.9 |
| 1,835 | 2,376 | 4,211 | 14.1 | 4.8 | 10.4 |
| 90% Reflective Ceiling | | | | | |
| -113 | -114 | -227 | -1.8 | -0.7 | -1.4 |
| -1,012 | -1,955 | -2,968 | -32.8 | -12.0 | -24.4 |
| 57 | 63 | 120 | 0.9 | 0.3 | 0.7 |
| -242 | -1,749 | -1,992 | -10.2 | -3.5 | -7.6 |
| Avg Savings 75% Reflective Ceiling | | | | | |
| | | | -15.6 | -5.6 | -11.8 |
| Avg Savings 90% Reflective Ceiling | | | | | |
| | | | 14.1 | 5.1 | 10.6 |
| Avg Savings 2x2 Troffer Ceiling | | | | | |
| | | | -10.2 | -3.6 | -7.7 |

Model Results - Trane Tracer

| Notherm Exposure | Area (SF) | Lighting Power Density (W/SF) | Annual Lighting Energy Used (KWh) | Total HVAC Energy in (KWh) | Total Annual Energy in (KWh) |
|-------------------------------|--------------|-------------------------------|-----------------------------------|----------------------------|------------------------------|
| 75% Reflective Ceiling | | | | | |
| 100 x 30 | 3000 | 1.2 | 22,021 | 13,069 | 35,090 |
| 60 x 60 | 3600 | 1.17 | 25,771 | 14,617 | 40,388 |
| Irregular | 4800 | 1.4 | 41,110 | 20,178 | 61,288 |
| Total | 11400 | 1.27 | 88,905 | 47,149 | 136,054 |
| 90% Reflective Ceiling | | | | | |
| 100 x 30 | 3000 | 0.96 | 17,620 | 12,179 | 29,799 |
| 60 x 60 | 3600 | 1 | 22,022 | 13,664 | 35,686 |
| Irregular | 4800 | 0.9 | 26,425 | 16,926 | 43,251 |
| Total | 11400 | 0.947 | 66,070 | 42,095 | 108,165 |
| 2x2 Troffer Ceiling | | | | | |
| 100 x 30 | 3000 | 1.12 | 20,552 | 12,806 | 33,358 |
| 60 x 60 | 3600 | 1.46 | 32,159 | 16,253 | 48,412 |
| Irregular | 4900 | 1.09 | 32,005 | 18,098 | 50,103 |
| Total | 11400 | 1.21 | 84,718 | 46,158 | 130,876 |
| ASHRAE 90.1 2004 | | | | | |
| 100 x 30 | 3000 | 1.1 | 20,187 | 12,698 | 32,886 |
| 60 x 60 | 3600 | 1.1 | 24,227 | 14,307 | 38,534 |
| Irregular | 4800 | 1.1 | 32,299 | 18,167 | 50,466 |
| Total | 11400 | 1.1 | 76,887 | 44,489 | 121,376 |

| Southern Exposure | Area (SF) | Lighting Power Density (W/SF) | Annual Lighting Energy Used (KWh) | Total HVAC Energy in (KWh) | Total Annual Energy in (KWh) |
|-------------------------------|--------------|-------------------------------|-----------------------------------|----------------------------|------------------------------|
| 75% Reflective Ceiling | | | | | |
| 100 x 30 | 3000 | 1.2 | 22,020 | 15,775 | 37,794,60331 |
| 60 x 60 | 3600 | 1.17 | 25,766 | 16,618 | 42,383,56001 |
| Irregular | 4800 | 1.4 | 41,114 | 21,286 | 62,400,2272 |
| Total | 11400 | 1.27 | 88,909 | 52,417 | 141,925,6321 |
| 90% Reflective Ceiling | | | | | |
| 100 x 30 | 3000 | 0.96 | 17,618 | 14,658 | 32,475,71338 |
| 60 x 60 | 3600 | 1 | 22,026 | 15,869 | 37,895,28865 |
| Irregular | 4800 | 0.9 | 26,430 | 17,987 | 44,416,8064 |
| Total | 11400 | 0.947 | 66,077 | 47,401 | 113,478,0768 |
| 2x2 Troffer Ceiling | | | | | |
| 100 x 30 | 3000 | 1.12 | 20,558 | 15,507 | 36,064,6304 |
| 60 x 60 | 3600 | 1.46 | 32,160 | 18,265 | 50,424,8939 |
| Irregular | 4800 | 1.09 | 32,011 | 19,244 | 51,255,06232 |
| Total | 11400 | 1.21 | 84,718 | 51,526 | 136,243,9793 |
| ASHRAE 90.1 2004 | | | | | |
| 100 x 30 | 3000 | 1.1 | 20,185 | 15,393 | 35,578 |
| 60 x 60 | 3600 | 1.1 | 24,226 | 16,310 | 40,535 |
| Irregular | 4800 | 1.1 | 32,304 | 19,307 | 51,610 |
| Total | 11400 | 1.1 | 76,892 | 49,777 | 126,689 |

